



interweave
healthcare

**PRODUCT CATALOGUE
2023**

CONTENTS

BEDDING

Polycotton	3
Cotton rich	4
Interfit	5
Fire retardant	6
Easycare polycotton	7
Non woven	8
Thermal throws	9
Blankets	10-11
Yellow blankets	12
Pillows & duvets	12-15
Mattress protection	16-17
Seclusion	18

TOWELS

Hospital towels	20
Plain white towels	20
Coloured towels	21
Baby towels	21
Kitchen linen	22

SCRUB SUITS

Performance scrubs	23-24
WonderWORK scrubs	25-26
Scrub cap & accessories	27

PATIENT WEAR

Adult gowns	28-30
Bariatric gowns	31
Dressing gowns	32
Mammogram cape	33
Interfaith gowns	34
Child gowns	35
Nightwear	36-37
Slipper socks	38
Bariatric socks	39
Compression socks	40
Baby wraps	41
Seclusion wear	42-43

PATIENT HANDLING

Patient comfort	44
Slide sheets	45-48
Transfer sheets	49
iPacks	49
Patient lifting	50
Accessories	51

PPE

Face masks & shields	52-53
Aprons	53

CURTAINS

Shower curtains	54
-----------------	----

LAUNDRY BAGS

Laundry bags	55
--------------	----

Interweave Healthcare, to help you care

Specialising in supplying healthcare products and patient handling products to hospitals, private clinics and nursing homes.

Trusted by healthcare professionals, laundry managers and business owners, buy online to benefit from:

- Credit card payments online
- Free UK mainland delivery for orders over £50
- Next day dispatch on orders placed by 3:30pm on weekdays*
- Delivery to private or commercial addresses

* 1-2 days delivery to UK mainland available on most items

KEY FEATURES



New product
added this year



Best selling
product in the range



Product we love,
handpicked by us



Product in
several colours



Flame
retardant product



Water resistant
product

POLYCOTTON BEDDING

POLYCOTTON SHEETS



Hard-working polycotton flat sheet to fit single beds. Ideal for hospital or nursing home use. Longer than domestic flat sheets to fit hospital bed.

- Suitable for laundering at thermal disinfection temperatures
- 130gsm weight

Product name	Size	Code	Supply chain code
Polycotton flat sheet - single bed	178cm x 275cm	ST010180275	VCS026
Polycotton flat sheet - cot	86cm x 112cm	ST810-86112	N/A
Polycotton flat sheet – single bed extra long	178cm x 300cm	ST010180300	N/A

POLYCOTTON EASYCARE FLAT SHEETS



Easycare polycotton sheet for both single and double beds. Available in white or cream. Flat bed sheets are ideal for us in nursing, & residential homes or domestic use.

- Washable at 50 degrees and needs minimal ironing
- Available in two neutral colours

Product name	Size	Code
Polycotton easycare flat sheet – single	180cm x 255cm	ST000180255
Polycotton easycare flat sheet - double	228c x 255cm	ST000228255

POLYCOTTON PILLOWCASES



Polycotton pillowcases are durable, comfortable and practical. Ideal for hospitals, nursing homes and other healthcare facilities.

- Suitable for laundering at thermal disinfection temperatures
- Larger than domestic pillowcases

Product name	Size	Code	Supply chain code
Polycotton housewife style pillowcase	55cm x 75cm	PC010	N1207519

POLYCOTTON DUVET COVERS

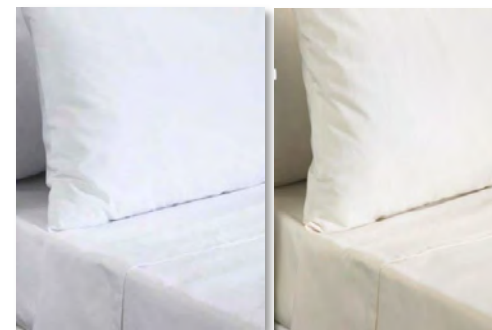

Single bed polycotton duvet covers for nursing homes & other institutions. Comfortable, durable and neutral colours available.

- Matching pillowcases available
- Matching fitted sheets available
- Available in white or cream

Product name	Size	Code
Polycotton duvet cover – single bed	137cm x 198cm	DC400137198
Polycotton duvet cover – double bed	198cm x 198cm	DC400198198

COTTON RICH BEDDING

COTTON RICH SHEETS



Cotton flat sheet to fit single beds, extra long single beds and cots. Ideal for hospital or nursing home use. Longer than domestic flat sheets to fit hospital beds. 130gsm weight.

- Hospital quality bed linen
- Suitable for laundering at thermal disinfection temperatures

Product	Size	Code
Cotton rich flat sheet - single bed	180cm x 275cm	ST075180275
Cotton rich flat sheet - single bed extra long	180cm x 300cm	ST070180300
Cotton rich flat sheet - cot	86cm x 115cm	ST824-86115

You might also like



Elite thermal throw pg. 9

COTTON RICH PILLOWCASES



Popular cotton rich hospital-quality pillowcases are highly durable & comfortable. Larger size for ease of fitting. Durable and comfortable fabric.

- Fabric weight 130gsm
- Suitable for laundering at thermal disinfection temperatures

Product name	Size	Code
Cotton rich housewife style pillowcase	55cm x 75cm	PC075
Cotton rich bag style pillowcase	51cm x 85cm	PC475

You might also like



Lap blankets pg. 9

INTERFIT BEDDING

INTERFIT FITTED SHEETS



Hard-wearing polycotton elasticated fitted sheet for single beds. Customer favourite for its no creasing.

- Fabric with flexible stretch
- Fits all healthcare mattresses
- Suitable for laundering at thermal disinfection temperatures

Product name	Size	Code
Interfit knitted fitted sheet	Single bed	ST426
Interfit knitted semi-fitted top sheet	Single bed	ST427

INTERFIT FITTED PILLOWCASES



Durable hospital-quality polycotton pillowcases with four stretch fabric. No ironing needed with easycare fabric.

- Full bedding range
- Suitable for laundering at thermal disinfection temperatures
- Extra stretchy material

Product name	Size	Code
Interfit knitted fitted pillowcase	46cm x 69cm	PC025



LAUNDRER HOT
For thermal disinfection,
after every use



FOUR WAY STRETCH
Only takes one person
to make a bed



EASYCARE
No creases, minimises
pressure sores



FULL BEDDING RANGE
Maximum patient comfort

FIRE RETARDANT BEDDING

FIRE RETARDANT SHEETS



Used by hospitals and nursing homes. BS7175 fire retardant polyester remains effective even after laundering.

- 100% FR polyester
- Double bed sheets in cream or white
- Hospital-grade bed linen

Product name	Size	Code
FR Flat sheet – single bed	180cm x 255cm	ST001180255
FR Flat sheet – double bed	228cm x 255cm	ST0001228255
FR Fitted sheet – single bed	90cm x 90cm	ST400-90190
FR Fitted sheet – double bed	137cm x 190cm	ST401137190

Colours available for single bedding / pillowcases



Burgundy Pink Cream White



Navy Blue Jade Light green

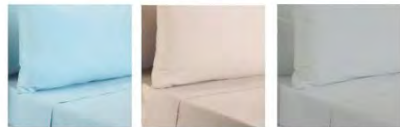

Duck egg Latte Silver

Double size



Cream

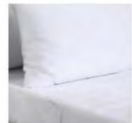

White

FIRE RETARDANT PILLOWCASES

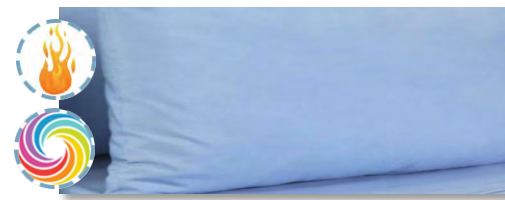

Pillowcases designed for hospitals & nursing homes in FR polyester. Complies with BS7175. Comfortable, practical and safe. Available in 10 colours.

Product name	Size	Code
FR polyester housewife style pillowcase	50cm x 75cm	PC001

FIRE RETARDANT V-SHAPED PILLOWCASES



Pillowcases designed to fit the Interweave V-shaped pillow in FR polyester. Available in white. Machine washable at 60 degrees.

Product name	Size	Code
FR polyester V pillowcase	73cm x 114cm	PC801

FIRE RETARDANT DUVET COVERS

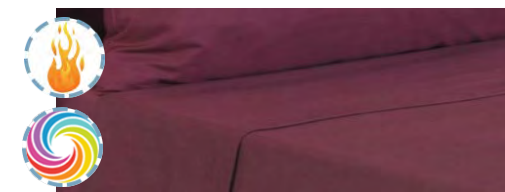

Fire retardant polyester duvet covers with matching bedding available. Double size available in cream or white.

Product name	Size	Code
FR duvet cover – single bed	137cm x 198cm	DC401
FR duvet cover – double bed	200cm x 200cm	DC401

EASYCARE POLYCOTTON BEDDING

EASYCARE POLYCOTTON SHEETS



Easycare polycotton bed sheets to fit single beds. Ideal for hospital or nursing home use. Hospital quality bed linen.

- Suitable for laundering at thermal disinfection temperatures
- 130gsm weight

Product name	Size	Code
Easycare polycotton flat sheet – single bed	180cm x 255cm	ST000180255
Easycare polycotton flat sheet – double bed	228cm x 255cm	ST000228255
Easycare polycotton fitted sheet – single bed	90cm x 190cm	ST400-90190
Easycare polycotton fitted sheet – double bed	137cm x 190cm	ST400137190

You might also like



Polyester cellular blankets pg. 10

DUVET COVERS



Single bed easycare polycotton duvet covers for nursing homes & other institutions. Comfortable and durable.

- Suitable for laundering at thermal disinfection temperatures
- Matching bedding available

Product name	Size	Code
Easycare polycotton duvet cover – single	137cm x 198cm	DC400137198
Easycare polycotton duvet cover - double	198cm x 198cm	DC400198198

EASYCARE POLYCOTTON PILLOWCASES



Easycare polycotton pillowcases are durable, comfortable and practical. Ideal for hospitals, nursing homes and other healthcare use.

- Suitable for laundering at thermal disinfection temperatures
- Available in white or cream

Product name	Size	Code
Easycare polycotton pillowcase	50cm x 75cm	PC000

NON-WOVEN DISPOSABLE BEDDING

NON-WOVEN DISPOSABLE SHEETS



Cost effective bedding solution for hospitals, clinics, salons and dentists. Nonwoven polypropylene disposable flat sheets to fit single beds.

- Ideal for contingency planning
- Ideal when no laundry facilities available

Product name	Size	Code
Disposable non-woven sheet - single bed	140cm x 229cm	ST033

NON-WOVEN DISPOSABLE PILLOWCASES



Cost effective bedding solution for hospitals, clinics, salons and dentists. Nonwoven polypropylene disposable flat sheets to fit single beds.

- Ideal for contingency planning
- Ideal when no laundry facilities available

Product name	Size	Code
Non-woven pillowcase housewife style	51cm x 76cm	PC033

Have you seen these compression socks?

Available in four sizes, see pg. 40



THERMAL THROWS

PREMIUM THERMAL THROW



Thermal throw blanket for single beds available in 2 colours. 100% polyester material.

- Complies with BS EN 12952
- Suitable for laundering at thermal disinfection temperatures



Product name	Size	Code
Premium throw- single bed	180cm x 255cm	BK554

ELITE THERMAL THROW



Polyester thermal blankets ideal for hospitals, nursing homes & rehabilitation centres. Single bed size available in 6 colours.

- Cot size available in cream – colours buy request
- Flame retardancy complies with BS EN 12952

Product name	Size	Code
Elite throw – single bed	168cm x 210cm	BK555168210
Elite throw - cot	86cm x 102cm	BK555-86102

Colours: Elite thermal throws & lap blankets

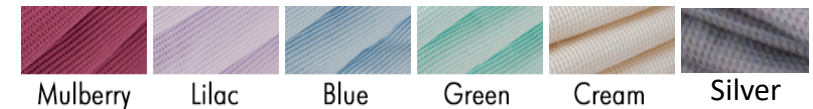

HEAVYWEIGHT THROW



Thermal throw blanket for single beds. Ideal for nursing homes, hospitals and rehabilitation centres. Flame retardant with BS EN 12952.

- 100% polyester material
- Available in blue

Product name	Size	Code
Heavyweight throw – single bed	180cm x 210cm	BK559

LAP BLANKETS



Designed to keep the lap and all around the legs warm whilst sitting. Ideal for care & nursing homes.

- Flame retardancy complies with BS EN 12952
- Large and small sizes available

Product name	Size	Code
Lap blankets – small	80cm x 102cm	BK555-80102
Lap blankets - large	102cm x 168cm	BK555102168

BLANKETS

POLYESTER CELLULAR BLANKETS



Easycare and comfortable. Used in various healthcare facilities. Single bed size are available in 5 colours. Cot blankets available online in 5 colours.

- 100% polyester fabric
- Cellular weave suitable for all seasons
- Flame retardant to BS7175

Product name	Size	Code	Supply chain code
Polyester cellular baby blanket - white	80cm x 102cm	BK250-80102	N/A
Polyester cellular baby blanket - coloured	80cm x 102cm	BK250-80102	N/A
Polyester cellular single bed blanket	165cm x 210cm	BK250165210	N1207511

Colours available for single bed & baby blankets



White Magnolia Maize Green Blue

Next day dispatch on all stocked blankets to UK mainland addresses. Simply buy online before 3:30pm*.

*Weekdays only



COTTON CELLULAR BLANKETS (BABY)



Soft & comfortable, easycare white cellular blankets for cribs and cots. Keeps babies warm in winter & comfortable in summer.

- Cellular weave for all seasons
- Used in maternity units, birthing centres and day nurseries

Product name	Size	Code
Cotton cellular crib blanket - white	73cm x 86cm	BK200-73-86
Cotton cellular cot blanket - white	86cm x 112cm	BK200-86112

WHITE SINGLE BED BLANKETS



Comfortable cotton white cellular blankets for single beds. Used by hospitals, nursing homes and local authorities. Washable at high temperatures.

- Cellular weave for all seasons
- Min order quantity: 25
- 100% soft cotton fabric

Product name	Size	Code	Supply chain code
Cotton cellular single bed blanket - white	170cm x 228cm	BK200178228	N1207510

BLANKETS & BEDSPREADS

TRELLIS FIRE RETARDANT BEDSPREADS



Flame retardant polyester counterpanes add weight and warmth to bedding. Used in nursing homes & hospitals.

- 100% polyester fabric
- Complies with FR regulation BS7175

Product name	Size	Code	Supply chain code
Trellis bedspread – single bed	180cm x 230cm	BS020180230	N1207509

MIDWEIGHT THERMAL THROW



Easycare midweight polyester hospital blanket. You can layer up these blankets for additional warmth, Thicker than the premium thermal throw.

- 100% polyester material
- Available in green
- No fluff transfer

Product name	Size	Code
Midweight throw – single bed	180cm x 210cm	BK553

POLAR FLEECE BLANKETS



Soft and comfortable, tan polar fleece single bed blankets used by hotels, nursing homes and other institutions for added warmth.

- 100% knitted polyester material
- Available in tan only

Product name	Size	Code
Polar fleece blanket tan – single	180cm x 230cm	BK828180230
Polar fleece blanket tan - double	230cm x 230cm	BK828230230
Polar fleece blanket tan - kingsize	230cm x 275cm	BK828230275

AMBULANCE BLANKETS



100% polyester ambulance blanket, essential item in first aid kits. Re-usable and launderable at thermal disinfection temperatures.

- Available in Mulberry red
- Durable fabric

Product name	Size	Code
Ambulance blanket	168cm x 210cm	BK555-MUL

YELLOW FALLS RISK BLANKETS

FALLS RISK FLEECE LAP BLANKET



Polyester patient specific fleece blanket in yellow. Helps identify patients at risk of falls. Comfortable and easy visual cue for staff and carers.

- 100% polyester fabric
- 71cm x 96cm

Product name	Size	Code
Falls risk fleece lap blanket	71cm x 96cm	BK801-71-96—CYELV76

POLYESTER CELLULAR FALLS RISK BLANKETS



Re-usable, launderable cellular blanket to identify patients at risk of falls. Available as lap blankets or single bed sizes. Flammability tested to BS7175.

- 100% polyester material
- Available in bright yellow
- Lap or single bed size

Product name	Size	Code
Polyester cellular falls risk blanket - lap	80cm x 102cm	BK250-80102---YELA37
Polyester cellular falls risk blanket – single bed	165cm x 210cm	BK250165210—CYELA37

Pair falls risk blankets with our fall prevention socks for an easy visual falls prevention kit...



See Fall Prevention socks on pg. 38

PILLOWS

FIRE RETARDANT WIPE CLEAN “GREEN TINT” PILLOWS



Medical grade pillows used on hospital wards, in nursing homes & by local authorities. Lightweight & practical pillow.

- Compliant with BS7175 Source 5
- Polypropylene filling
- Made in the UK

Product name	Size	Code
FR Wipe clean green tint pillows	46cm x 69cm	PW027

FIRE RETARDANT HOLLOWFIBRE PILLOWS



Flame retardant hollowfibre pillows used in hospitals and nursing homes. Fire retardant cover – complies with BS7175 Source 5.

- Proban treated material
- Weighs 500g
- Made in the UK

Product name	Size	Code
FR hollowfibre pillows	45cm x 68cm	PW005

HOLLOWFIBRE PILLOWS



Long lasting hollowfibre ensures these pillows are comfortable yet durable. Ideal for hospitals and nursing homes for comfort.

- Comfortable hollowfibre pillow
- Pillow weighs 450g
- Made in the UK

Product name	Size	Code
Hollowfibre pillows	45cm x 68cm	PW003

FIRE RETARDANT WATERPROOF PILLOWS



Used by hospitals, nursing homes and local authorities. Flame retardant wipe clean polyester hollowfibre pillows.

- Compliant with BS7175 Source 5
- Ultra high frequency welded seams
- Made in the UK

Product name	Size	Code
FR wipe clean polyester pillows	48cm x 75cm	PW019

PILLOWS

CONTINENTAL PILLOWS

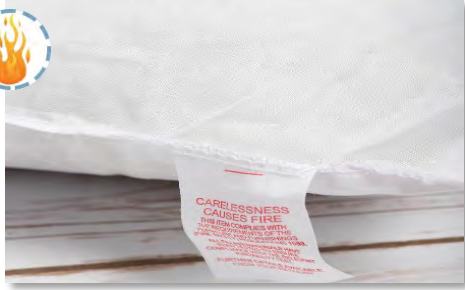

Larger and heavier than standard pillows, ideal for use in nursing homes. Hollowfibre filling and polycotton cover. Pillow weighs 650g.

- Hollowfibre filling
- Made in the UK
- Cover made from easycare polycotton fabric

Product name	Size	Code
Continental pillows	50cm x 76cm	PW001

CURLED FEATHER PILLOW



Flatter shaped pillow than other fillings. Filled with curled duck feathers. Pillow weighs 1kg. Made in the UK.

- Polycotton cover
- Curled feather filling
- Available in white

Product name	Size	Code
Curled feather pillow	50cm x 75cm	PW000

V-SHAPED WIPE CLEAN PILLOWS



Lightweight and comfortable, the V-shaped pillow supports the head, neck and shoulders. The "Drishield" cover is wipe clean and flame retardant to BS7175 Source 5.

- Pale green tint colour
- Unique V shape

Product name	Size	Code
V shaped pillow	73cm x 110cm	PW922

SCRUBS: 8 COLOURS AVAILABLE IN 8 SIZES

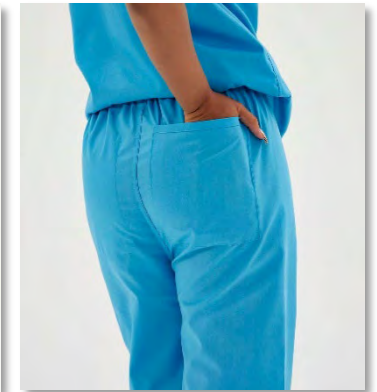

See on pg. 23-24

DUVETS

FIRE RETARDANT WIPE CLEAN DUVET



Fire retardant wipe clean hollowfibre 10.5 tog duvets used in hospitals and nursing homes. Drishield wipeable duvet. Made in the UK.

- Compliant with BS7175 Source 5
- Polypropylene cover
- All seasons 10.5 tog weight

Product name	Size	Code
FR wipe clean duvet – single bed	135cm x 200cm	DV127135200
FR wipe clean duvet – double bed	200cm x 200cm	DV127200200

FIRE RETARDANT WATERPROOF DUVETS



Used by hospitals and nursing homes, these waterproof hollowfibre duvets are lightweight and practical. Made in the UK.

- Ultra high frequency welded seams
- Fire retardant to BS7175 Source 5
- Lightweight 9 tog weight

Product name	Size	Code
Waterproof duvet – single bed	137cm x 198cm	DV501137198
Waterproof duvet – double bed	190cm x 190cm	DV501198198

FIRE RETARDANT HOLLOWFIBRE DUVETS



Fire retardant hollowfibre 10.5 tog single and double duvets used in hospitals and nursing homes. Complies with BS7175 Source 5.

- All seasons 10.5 tog weight
- Made in the UK
- 100% cotton cover

Product name	Size	Code
FR hollowfibre duvet – single bed	135cm x 200cm	DV100135200
FR hollowfibre duvet – double bed	200cm x 200cm	DV100198198

HOLLOWFIBRE DUVETS



Lightweight, inexpensive hollowfibre duvet. All seasons 10.5 tog weight. Long-lasting, durable and comfortable. Made in the UK.

- Washable at 40 degrees
- Polycotton cover
- Polyester hollowfibre filling

Product name	Size	Code
Hollowfibre duvet – single bed	137cm x 198cm	DV110137198
Hollowfibre duvet – double bed	198cm x 198cm	DV110198198

MATTRESS PROTECTION: DRAW SHEETS

UNBLEACHED DRAW SHEETS



100% unbleached cotton draw sheet, used by hospitals and nursing homes. Place under the sheet for added comfort & mattress protection.

- Unbleached cotton twill
- Durable fabric
- Protect against accidental leaks and spills

Product name	Size	Code	Supply chain code
Unbleached draw sheet – single bed	115cm x 185cm	DS000115185	N1207513

COTTON FLANNELETTE DRAW SHEETS



Warm cotton flannelette draw sheets protects the mattress and add comfort for the patient. Used in hospitals and nursing homes.

- 100% cotton white flannelette
- Protect against accidental leaks and spills

Product name	Size	Code
Cotton flannelette draw sheet – single bed	115cm x 185cm	DS015115185

COTTON RICH DRAW SHEETS



Used in hospitals & nursing homes, this draw sheet is used as a base sheet under regular bedding. Cost effective way to protect the mattress and sheets without using plastic.

- Easycare washing and fast drying
- Protect against accidental leaks and spills

Product name	Size	Code
Cotton rich white draw sheet – single bed	115cm x 178cm	DS075115178

You might also like

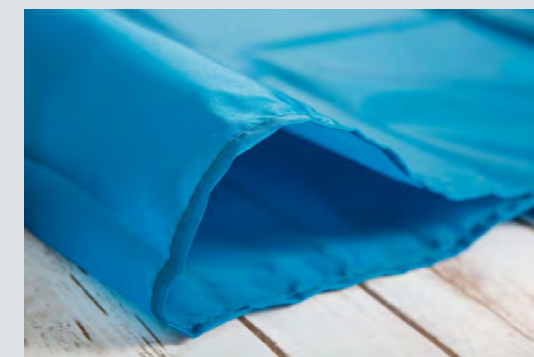

Flat slide sheets and tubular slide sheets on page 45-48

MATTRESS PROTECTORS

POLYCOTTON QUILTED MATTRESS PROTECTOR



Fully fitted quilted mattress protector for single beds. Used in hospitals, nursing homes & local authority temporary accommodation.

- Waterproof layer inside
- Protect against accidental leaks and spills
- Elasticated edges

Product name	Size	Code
Polycotton quilted protector – single bed	90cm x 190cm	MP001-90190
Polycotton quilted protector – double bed	137cm x 190cm	MP001137190



View heel protectors on page 44

WATERPROOF POLYPROPYLENE MATTRESS PROTECTOR



Quilted waterproof mattress protectors to cover single bed mattresses as used in nursing homes and hospitals.

- Polypropylene cover
- Fully fitted with elasticated edges
- Protect against accidental leaks and spills

Product name	Size	Code
Waterproof polypropylene – single bed	91cm x 190cm	MP015-91190
Waterproof polypropylene – double bed	137cm x 109cm	MP015137190

Three reasons to open an online account

With an online Interweave account, you can:

1. Buy online without having to enter your personal details each time;
2. Re-order your favourites very easily, with the Quick re-order form; and
3. Access discounted prices and web-only special offers.

Apply today!

SECLUSION BEDDING

CUSTODY BLANKET



Blanket made from single layer polyester fabric.

- Bedding size: single
- Available in green
- Complies with flame retardant regulation BS5185
- For use in combination with supervision

Product name	Size	Code
Custody blanket	180cm x 230cm	BS050180230

SECLUSION BLANKET



Heavyweight dual-layer blanket made from Secure-TEX fabric, designed for use in prisons and prison cells.

- Bedding size: single
- Available in green
- Complies with flame retardant regulation BS7175 Source 7
- For use in combination with supervision

Product name	Size	Code
Seclusion blanket	145cm x 180cm	BK850145180

SECLUSION MATTRESS COVER



Heavyweight dual-layer blanket made from Secure-TEX fabric with mattress shaping & elasticated edges. Closes with a Velcro strip.

- Bedding size: single
- Covers 19cm deep mattress
- Complies with flame retardant regulation BS5185
- For use in combination with supervision

Product name	Size	Code
Seclusion mattress cover	92cm x 183cm	MP050-92193

SECLUSION SEALED PILLOW



Sealed pillow with heavyweight Secure-TEX fabric cover.

- Hollowfibre polyester filling
- Available in green
- Complies with flame retardant regulation BS5185
- For use in combination with supervision

50

Product name	Size	Code
Seclusion sealed pillow	45cm x 68cm	PW047-45-68



Buy all this online today – Free delivery on orders over £50! *



* applies to UK mainland delivery addresses

HOSPITAL TOWELS & WHITE TOWELS

HOSPITAL PROPERTY TOWELS



Highly absorbent white cotton towels with Hospital Property interwoven across the centre of the towel. Suitable for laundering at thermal disinfection temperatures.

- 100% cotton
- Designed for quick drying

Product name	Size	Code	Supply chain code
Hospital property hand towels	40cm x 100cm	TW202-48100	N/A
Hospital property bath towels	65cm x 125cm	TW312-65125	N1207522
Hospital property bath sheets	90cm x 150cm	TW802-90150	N/A

COTTON TOWELLING WIPE

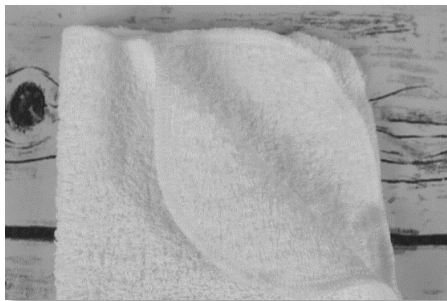

Cotton towelling wipe available in multiples of 10. Overlocked edges for better durability.

- Reusable cotton wipes
- Available in white
- Durable

Product name	Size	Code
Cotton towelling wipe	30cm x 30cm	TW070-30-30

CONTRACT WHITE TOWELS



Highly absorbent white cotton towels. Used by care homes, hotels and private hospitals. 500gsm cotton fabric.

- Various sizes available
- Soft and durable
- Available in white

Product name	Size	Code
Contract white face cloths	30cm x 30cm	TW039-30-30
Contract white hand towels	50cm x 90cm	TW239-50-90
Contract white bath towels	70cm x 135cm	TW439-70135
Contract white bath sheets	100cm x 150cm	TW839100150

BATHMATS



100% cotton bathmat for use in care homes, nursing homes, hotels and private hospitals. Washes well at high temperatures.

- Highly absorbent material
- Soft and durable

Product name	Size	Code
Contract white bathmats	51cm x 76cm	TW930-51-76

PLAIN COLOURED TOWELS

FACE CLOTHS & TOWELS



100% carded cotton towels are suitable for care homes, nursing homes, private hospitals and hospitality. 480gsm weight.

- Durable and soft
- Quick to dry
- Available in 14 colours

Product name	Size	Code
Coloured face cloths – various colours	30cm x 30cm	TW053
Coloured hand towels – various colours	50cm x 90cm	TW253
Coloured bath towels – various colours	70cm x 125cm	TW453
Coloured bath sheets – various colours	90cm x 150cm	TW853



MIRAGE BATH MAT



Comfortable 100% cotton bathmat at 750gsm weight. Durable and soft. Used in nursing homes, care homes and private hospitals.

- Available in white & ivory
- Soft and comfortable material

Product name	Size	Code
Mirage bathmat – white or ivory	50cm x 80cm	TW953-50-80

BABY HOODED TOWEL



Soft white 100% cotton baby towel with built in hood. 400gsm weight for a lightweight, soft towel that is highly absorbent and dries quickly.

- Suitable for hospital laundries
- Lightweight soft white towel
- Built-in hood

Product name	Size	Code
Hooded baby towel - white	68cm x 68cm	TW712-68-68

KITCHEN LINEN

KITCHEN TOWEL



100% cotton herringbone white kitchen towel with a green border. Used by nursing homes, care homes and hospitals. Ideal for any catering environment.

- Suitable for laundering at thermal disinfection temperatures

Product name	Size	Code
Kitchen towel	50cm x 75cm	TT600-50-75

OVEN CLOTH



Unbleached cotton oven cloth, in herringbone weave. Used by nursing homes, care homes and hospitals. Ideal for any catering environment.

- Suitable for laundering at thermal disinfection temperatures
- 100% cotton

Product name	Size	Code
Oven cloth	50cm x 75cm	TT800-50-76

TEA TOWEL



100% cotton tea towel with a blue border. Used by nursing homes, care homes, and hospitals. Ideal for any catering environment.

- Quick drying
- Suitable for laundering at thermal disinfection temperatures

Product name	Size	Code
Tea towel	50cm x 75cm	TT002-50-75

Next day dispatch on all stocked kitchen linens to UK mainland addresses. Simply buy online before 3:30pm*.

*Weekdays only



SCRUB SUITS

SCRUB SUIT TOPS



Unisex V-neck scrubs suit top worn by healthcare professionals, including nurses, doctors, dentistry staff and vets. The polycotton scrubs top is reversible, with a hip pocket on both the inside and outside.

- Available in 8 colours
- Colour coded neck binding for sizing
- Available in 8 sizes: XS-4XL
- Suitable for laundering at thermal disinfection temperatures

Colours available

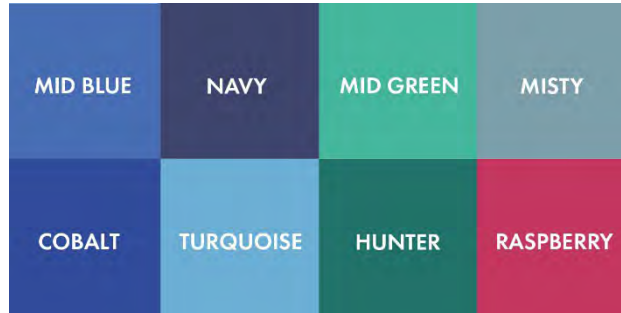

Scrub suit top sizing	XS	S	M	L	XL	XXL	XXXL	4XL
Chest circumference (cm)	101	107	119	129	142	147	154	163

Product name	Size	Code
Scrub suit top – various sizes & colours	XS-4XL	SS017

SCRUB SUIT TROUSERS



The scrub suit trousers feature a rear square pocket, which is available on both the inside and outside. Draw cord waist. These unisex trousers are worn by healthcare professionals including nurses, doctors, dentistry staff & vets.

- Available in 8 colours
- Colour coded waist cord for sizing
- Available in 8 sizes: XS-4XL
- Suitable for laundering at thermal disinfection temperatures

Colours available



Scrub suit top sizing	XS	S	M	L	XL	XXL	XXXL	4XL
Chest circumference (cm)	101	107	119	129	142	147	154	163

Product name	Size	Code
Scrub suit trousers – various sizes & colours	XS-4XL	SS417

SCRUB SUITS

WARM UP JACKET



Comfortable polycotton long sleeved jacket designed to wear over scrub suits, Easycare and washes well time after time.

- Available in 2 colours
- Available in 6 sizes: S – XXL
- Elasticated cuffs
- Suitable for laundering at thermal disinfection temperatures

Colours available



Mid blue



Mid green



Warm up jacket sizing	S	M	L	XL	XXL
Chest circumference (cm)	107	119	129	142	147

Product name	Size	Code
Warm up jacket – available in 2 colours	S – 3XL	SS817

SCRUB SUITS: WONDERWORK TOPS

UNISEX V-NECK SCRUB TOP

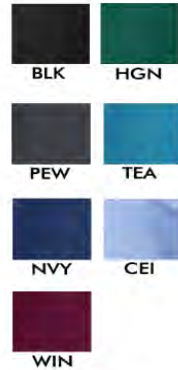

Basic fit scrub top designed to flatter any figure. Motion stretch fabric with double chest pockets.

- Available in 6 colours
- 65% polyester & 35% cotton
- Comfortable fabric

Product name	Size	Code
Unisex V neck scrub top	S - XXL	SS100

MENS V-NECK SCRUB TOP



V neck scrub top with special motion stretch fabric for whole shift comfort. High thread count fabric.

- Available in 6 colours
- 65% polyester & 35% cotton
- Comfortable fabric

Product name	Size	Code
Men's V neck scrub top	S - XXL	SS103

WOMENS V-NECK SCRUB TOP

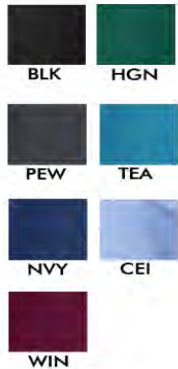

Comfortable V neck design made with motion stretch fabric. Flattering fit with two deep front pockets.

- Available in 6 colours
- 65% polyester & 35% cotton
- Machine washable up to 60 degrees

Product name	Size	Code
Unisex V neck scrub top	S - XXL	SS101

Unisex Size Guide

Sizes (cm)	XXS	XS	S	M	L	XL	2XL	3XL	4XL	5XL
Chest	78	83	89	97	104	114	124	134	145	155
Waist	58	63	68	76	83	94	104	114	124	134

Women's Size Guide

Sizes (cm)	XXS	XS	S	M	L	XL	2XL	3XL	4XL	5XL
Chest	76	81	86	91	99	109	119	129	139	149
Waist	55	60	66	71	78	88	99	109	119	129

Men's Size Guide

Sizes (cm)	XXS	XS	S	M	L	XL	2XL	3XL	4XL	5XL
Chest	78	83	89	97	104	114	124	134	145	155
Waist	58	63	68	76	83	94	104	114	124	134

SCRUB SUITS: WONDERWORK TROUSERS

UNISEX CARGO SCRUBS TROUSERS

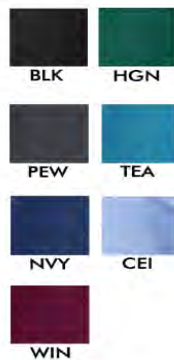

Classic cargo scrub design with back pocket & leg multi pocket. Stylish and flattering with a special stretch fabric.

- Available in 7 colours
- 65% polyester & 35% cotton
- Drawstring waist

Product name	Size	Code
Unisex cargo scrub trousers	S - XXL	SS500

MENS CARGO SCRUB TROUSERS



Comfortable scrub trousers with motion stretch fabric. Part elasticated & drawstring waist.

- Available in 6 colours
- 65% polyester & 35% cotton
- Features 5 pockets

Product name	Size	Code
Men's cargo scrub trousers	S - XXL	SS530

WOMENS PULL-ON CARGO SCRUB TROUSERS

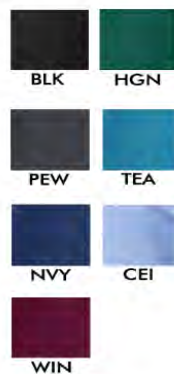

Slimline scrub trousers with a motion stretch fabric for comfort. Elasticated waist with multiple pockets.

- Available in 6 colours
- 65% polyester & 35% cotton
- Higher waistband for extra coverage

Product name	Size	Code
Women's pull-on cargo scrub trousers	S - XL	SS534

Unisex Size Guide

Sizes (cm)	XXS	XS	S	M	L	XL	2XL	3XL	4XL	5XL
Hips	81	86	91	99	106	116	127	137	147	157
In-seam length: Regular: 78cm, Short: 71cm, Long: 83cm										

Women's Size Guide

Sizes (cm)	XXS	XS	S	M	L	XL	2XL	3XL	4XL	5XL
Hips	83	88	91	96	104	114	124	134	149	160
In-seam length: Regular: 78cm, Short: 71cm, Long: 83cm										

Men's Size Guide

Sizes (cm)	XXS	XS	S	M	L	XL	2XL	3XL	4XL	5XL
Hips	83	88	91	96	104	114	124	134	149	160
In-seam length: Regular: 78cm, Short: 71cm, Long: 83cm										

SCRUB ACCESSORIES

SCRUB CAPS



Comfortable scrubs caps that can be matched with scrubs. Keeps hair neat and tidy all shift. Tie tapes & elasticated back.

- One size fits all
- Machine washable up to 60 degrees
- Absorbent towelling strip inside cap
- 65% polyester & 35% cotton

Product name	Size	Code
Scrub caps - various	One size	SS701



Navy



Cobalt



Mid blue



Raspberry



Mid green



Misty

WONDERWINK SCRUB CAPS



Comfortable and stylish scrub caps can be matched with WW scrubs. Keeps hair neat and tidy all shift.

- One size fits all
- Terry cloth sweatband sewn inside
- Available in navy blue
- Tie back closure – covered elastic band

Product name	Size	Code
WonderWink scrub caps	One size	SS7000NE

SIZE BINDING TAPE FOR SCRUB SUITS



Binding taped used to indicate garment sizes for scrubs. Colour coded per size for easy and fast identification.

- Available in 8 colours for sizes
- Used in NHS scrubs
- Sold in rolls of 100 metres

Product name	Size	Code
Size binding tape	XS-4XL	TA001

PATIENT GOWNS

LAPOVER HOSPITAL GOWN



Best selling hospital gown. Comfortable to wear, washes at high temperatures. Polycotton fabric with diamond pattern.

- Fastens with colour-coded ties
- Wrapover at the back with dignity tie
- Suitable for laundering at thermal disinfection temperatures

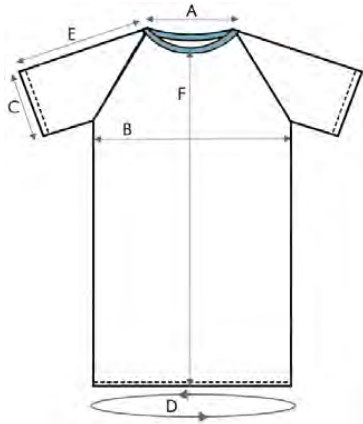

A Neck circumference	65cm	D Sweep around bottom	155cm
B Chest circumference	146cm	E Arm length	45cm
C Cuff circumference	48cm	F Length from shoulder high point	120cm

Product name	Size	Code
Lapover hospital gown	One size	PG044

DIGNITY HOSPITAL GOWN



Classed as “outstanding” in an independent report. Reversible front and back patient gown in striped blue and white polycotton easy care fabric.

- Ties at the front or back
- Fastens with colour-coded ties
- Suitable for laundering at thermal disinfection temperatures

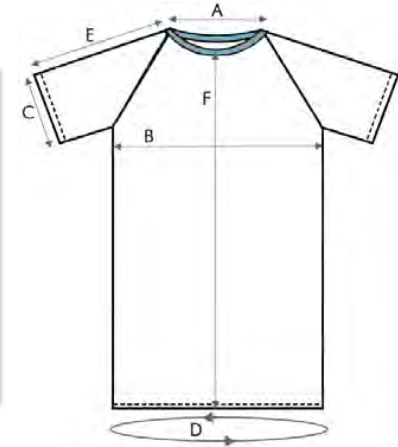

A Neck circumference	90cm	D Sweep around bottom	172cm
B Chest circumference	140cm	E Arm length	30cm
C Cuff circumference	58cm	F Length from shoulder high point	123cm

Product name	Size	Code
Dignity hospital gown	One size	PG825

PATIENT GOWNS

POPPER HOSPITAL GOWN



Round necked patient gown in easycare fabric has popper fasteners on the shoulders & at the back. Ideal for any medical procedure.

- No ties – popper fasteners on both shoulders and back
- MRI-friendly plastic popper tape
- Suitable for laundering at thermal disinfection temperatures

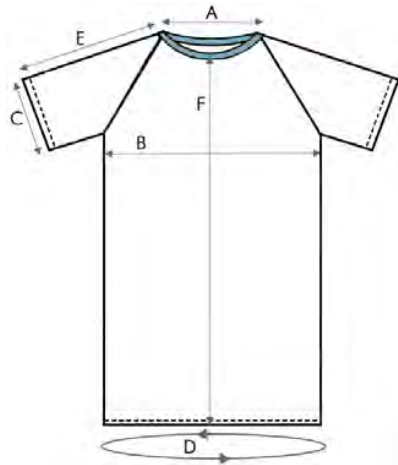
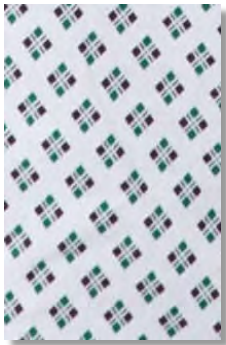

A Neck circumference	49cm	D Sweep around bottom	144cm
B Chest circumference	142cm	E Arm length	0cm
C Arm hole opening	47cm	F Length from shoulder high point	112cm

Product name	Size	Code
Popper hospital gown	Adult size	PG038

THREE ARM TOGA HOSPITAL GOWN



Three-armed toga hospital patient gown is easy to put on, no ties or poppers to struggle with.

- Unique design provides improved patient dignity
- Blue diamond polycotton fabric print
- Suitable for laundering at thermal disinfection temperatures

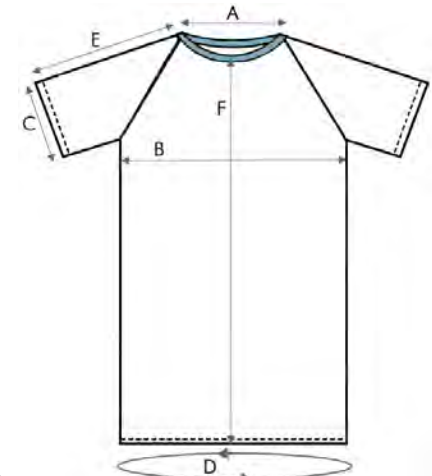
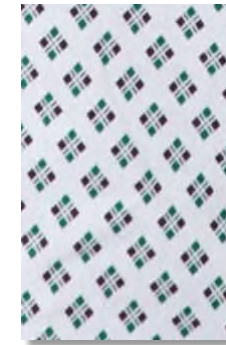

A Neck circumference	89cm	D Sweep around bottom	250cm
B Chest circumference	164cm	E Arm length	43cm
C Cuff circumference	45cm	F Length from shoulder high point	127cm

Product name	Size	Code
Three arm toga hospital gown	Adult size	PG040

PATIENT GOWNS

OPERATION HOSPITAL GOWN



Simple white unisex polycotton operation gown designed to be easy to wear. Providing excellent access to the rear.

- Three ties that fasten at the back
- MRI friendly
- Suitable for laundering at thermal disinfection temperatures

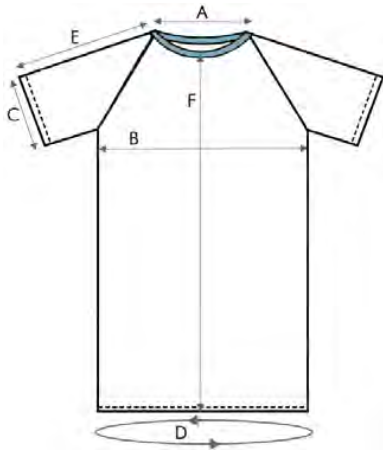

A Neck circumference	74cm	D Sweep around bottom	155cm
B Chest circumference	140cm	E Arm length	33cm
C Cuff circumference	50cm	F Length from shoulder high point	127cm

Product name	Size	Code
Operation hospital gown	Adult size	PG000

PULLOVER HOSPITAL GOWN



Easy to put on over the head, no ties or poppers to fasten. Comfortable polycotton hospital gown.

- MRI friendly
- Long opening at the back
- Suitable for laundering at thermal disinfection temperatures

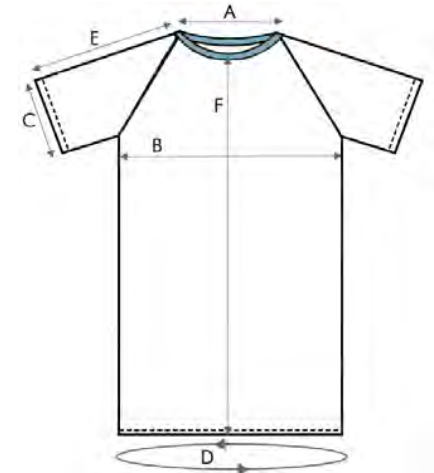
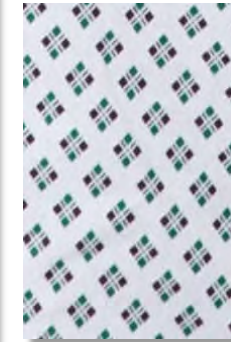

A Neck circumference	65cm	D Sweep around bottom	160cm
B Chest circumference	148cm	E Arm length	43cm
C Cuff circumference	48cm	F Length from shoulder high point	128cm

Product name	Size	Code
Pullover hospital gown	Adult size	PG033

BARIATRIC PATIENT GOWNS

BARIATRIC 4XL HOSPITAL GOWN



Plus size bariatric patient gown is easy to put on and comfortable to wear. Made from easycare polycotton.

- Fastens with colour-coded ties
- Wrapover at the back with dignity tie
- Suitable for laundering at thermal disinfection temperatures

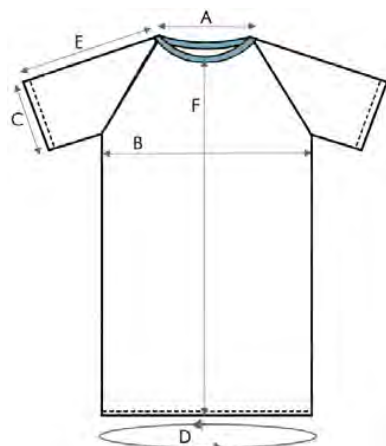
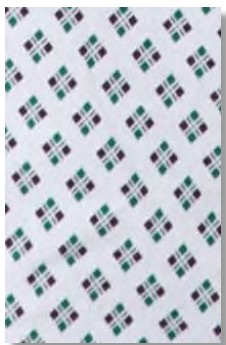

A Neck circumference	92cm	D Sweep around bottom	180cm
B Chest circumference	164cm	E Arm length	47cm
C Cuff circumference	56cm	F Length from shoulder high point	122cm

Product name	Size	Code
Bariatric 4XL hospital gown	One size	PG0444XL

BARIATRIC 10XL HOSPITAL GOWN



10XL bariatric patient gown is easy to put on and very comfortable to wear. Made from easycare polycotton.

- MRI friendly
- Opening at the back, with ties at the neck & waist, with wrapover
- Suitable for laundering at thermal disinfection temperatures

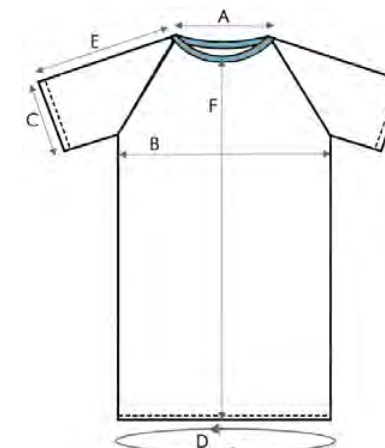

A Neck circumference	106cm	D Sweep around bottom	263cm
B Chest circumference	244cm	E Arm length	44cm
C Cuff circumference	84cm	F Length from shoulder high point	120cm

Product name	Size	Code
Bariatric 10XL hospital gown	One size	PG00410L

DRESSING GOWNS

DRESSING GOWN



Polycotton unisex dressing gown fits all sizes.
Mid length gown with waist tie.

- Unisex patient robe
- Lightweight polycotton fabric
- Suitable for laundering at thermal disinfection temperatures

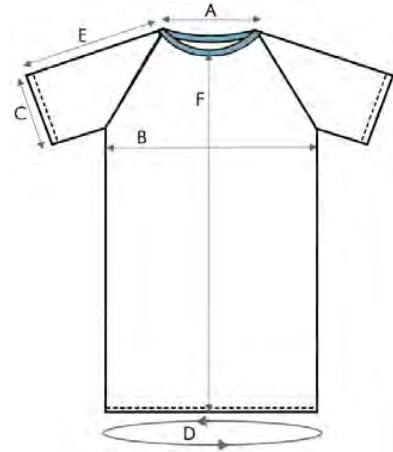

A Neck circumference	N/A	D Sweep around bottom	142cm
B Chest circumference	140cm	E Arm length	34cm
C Cuff circumference	45cm	F Length from shoulder high point	117cm



Product name	Size	Code
Dressing gown – blue stripe	One size	PG815

MAMMOGRAM GOWNS

MAMMOGRAPHY CAPE



Hospital gown for mammography procedures.
Easy to put on, poppers down the front.

- Lightweight polycotton fabric
- Available in blue and white stripes
- Suitable for laundering at thermal disinfection temperatures



A Neck circumference	54cm	C Arm length	58cm
B Sweep around bottom	450cm	D Length from shoulder high point	83cm

Product name	Size	Code
Mammography cape	One size	PG047



LAUNDRER HOT
For thermal disinfection, after every use



FOUR WAY STRETCH
Only takes one person to make a bed



EASYCARE
No creases, minimises pressure sores



FULL BEDDING RANGE
Maximum patient comfort

Browse the Interfit bedding range on page 5

INTERFAITH PATIENT GOWNS

HEAD SCARF



Head scarf to be worn in hospital to provide patient dignity and fully cover the head and hair.

Wear with the Interfaith patient gown and other accessories.

Product name	Size	Code
Interfaith head scarf	82cm x 82cm	PG602-82

FACE COVER



Female patients face cover for modesty when in hospital.

Product name	Size	Code
Interfaith face cover	36cm X 31cm	PG604-36-31

TROUSERS



Hospital gown trousers to be worn with the Interfaith hospital gown and accessories.

Suitable for female patients who wish to remain covered up.

Product name	Size	Code
Interfaith trousers	One size	PG601

CHILDRENS HOSPITAL GOWN

BABY PRINTED HOSPITAL GOWN



Operation gown for babies, made from soft patterned cotton flannelette. Tie at the back with cotton ties.

- Suitable for laundering at thermal disinfection temperatures
- Available in nursery rhyme pattern

Product name	Size	Code
Baby hospital gown - printed	One size	PG401



CHILDREN'S HOSPITAL GOWN



Polycotton hospital operation gown for children in fun print design. Easy fasten with cotton ties at the back. Seaside print.

- Suitable for laundering at thermal disinfection temperatures
- Colour coded tie tapes for sizing

Product name	Size	Code
Child hospital gown - printed	S - XL	PG400

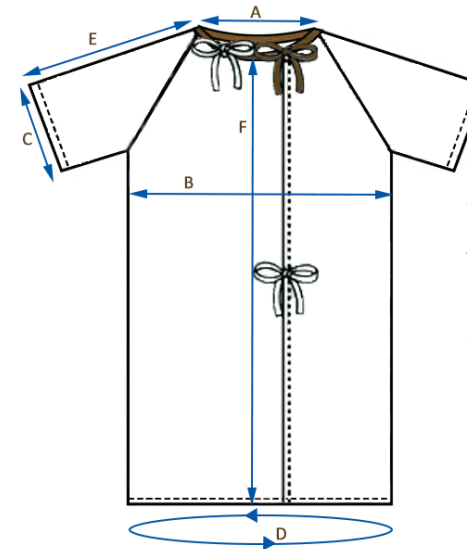

Children's hospital gown

Sizes (cm)	S	M	L	XL
A Neck circumference	32	36	40	50
B Chest circumference	74	86	108	116
C Cuff circumference	30	33	37	42
D Sweep around bottom	82	100	116	129
E Arm length	26	30	34	37
F Gown length	38	53	67	82

NIGHTWEAR

OPEN BACKED NIGHTDRESS



Open-backed polycotton hospital nightdress is designed to be worn loose and comfortable. The cross-over neck has increased dignity.

At the back, the lower half has a wrap-over split for easy access.

- Colour coded neck binding for sizing
- Suitable for laundering at thermal disinfection temperatures

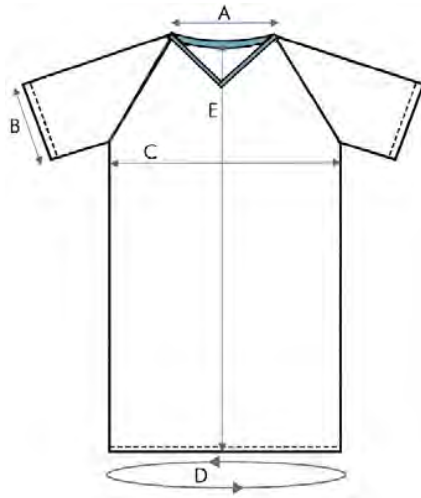

Sizes (cm)	Adult	4XL
A Neck circumference	62	62
B Sleeve circumference	46	56
C Chest circumference	128	146
D Sweep around bottom	148	177
E Length	110	115

Product name	Size	Code
Open backed nightdress	Adult & 4XL	NW405

CLOSED BACK NIGHTDRESS



This hospital nightdress has a closed back design, short sleeves and a cross-over top for increased dignity.

Easycare polycotton. Available in "hospital use only" print.

- Colour coded neck binding for sizing
- Suitable for laundering at thermal disinfection temperatures



Sizes (cm)	Adult	4XL
A Neck circumference	62	62
B Sleeve circumference	46	56
C Chest circumference	128	146
D Sweep around bottom	148	177
E Length	110	115

Product name	Size	Code
Closed back nightdress	Adult & 4XL	NW605

NIGHTWEAR

PYJAMA JACKET & TROUSERS



Lightweight unisex polycotton hospital pyjama jacket and separate trousers in “Hospital use only” print. Four clear plastic buttons.

- Trousers have elasticated waist with button & fly
- Suitable for laundering at thermal disinfection temperatures

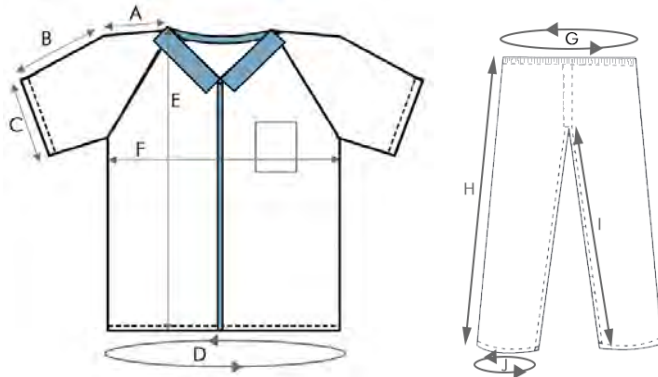

TOP: Sizes (cm)	XL	4XL
A Shoulder	22	25
B Arm length	58	62
C Cuff circumference	38	40
D Sweep around bottom	142	156
E Length	76	82
F Chest circumference	142	156

TROUSERS: Sizes (cm)	XL	4XL
G Waist (relaxed)	66	84
G Waist (stretched)	142	156
H Outside leg	106	114
I Inside leg	71	74
J Cuff circumference	50	57

Product name	Size	Code
Pyjama jacket	XL, 4XL	NW005
Pyjama trousers	XL, 4XL	NW202

NIGHTSHIRT



Polycotton hospital nightshirt in “Hospital use only” forest print. At the back, the lower half has a wrap-over split for convenience and easy access,

- 4 clear plastic buttons
- Open back
- Suitable for laundering at thermal disinfection temperatures

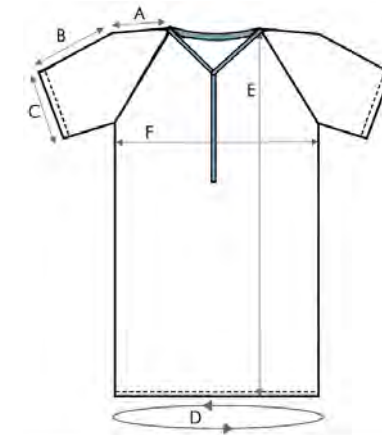

Sizes (cm)	XL
A Shoulder	17
B Arm length	27
C Cuff circumference	44
D Sweep around bottom	132
E Length	106
F Chest circumference	119

Product name	Size	Code
Hospital nightshirt	XL	NW897

SLIPPER SOCKS

SINGLE TREAD



Reduce the risk of falling accidents with latex free slipper socks for patients and nursing home residents. Stretchy sock fits comfortably.

- Latex free unisex socks
- Tread on the sole of the foot
- Not suitable for laundering

Product name	Size	Code	Supply chain code
Single tread slipper socks	XS-XXL	SK000	Various

FALL PREVENTION



Fall prevention slipper socks in bright yellow and bright red for patients who are at a high risk of falling. Helps identify these patients easily.

- Not suitable for laundering
- Tread on both sides of the foot

Product name	Size	Code	Supply chain code
S - XXL	S - XL	SK002-YEL	Various
Fall prevention socks red	XL only	SK002-RED	Various

DOUBLE TREAD



Latex free slipper socks patients with tread under the sole and on top of the foot. Reduces falls risk. Easy to put on and reduces risk of incorrect use,

- Not suitable for laundering
- Tread on both sides of the foot

Product name	Size	Code	Supply chain code
Double tread slipper socks	S - 3XL	SK001	Various

Sizes (cm)	XS	S	M	L	XL	XXL	3XL
UK Shoe size	1-2	3-4	4-5	5-8	8-11	11-13	13+
Colour	Yellow	Red	Green	Blue	Beige	Grey	Dk grey

Please note: We recommend always buying one size larger than your regular shoe size.

BARIATRIC SLIPPER SOCKS

BARIATRIC OEDEMA NON SLIP SOCKS



Bariatric oedema non slip socks have tread on both sides of the foot. They are suitable for swollen legs and ankles. Comfortable and breathable fabric to suit those recovering from surgery or treatment.

- Extra wide socks
- Stretches to 44cm around foot & 64cm around calf
- Stretchy mesh netting fabric

Product name	Size	Code	Supply chain code
Bariatric oedema slipper socks	XXXL	SK003	Dark Grey



Next day dispatch on all stocked Bariatric socks to UK mainland addresses. Simply buy online before 3:30pm*.

*Weekdays only



COMPRESSION SOCKS



HEALTHYLEGS COMPRESSION SOCKS



Clinically effective at reducing the risk of DVT. The socks apply graduated compression up the legs to improve circulation over time. Can support varicose veins, and ease aches and pain in legs.

- Closed toe with inspection hole
- Machine washable
- Below knee socks
- Comfortable heel patch

Product name	Size	Code
HealthyLegs compression socks	S - XL	SK801

Size Guide:

Please check measurements before ordering

Ankle circumference (cm)

Ankle circumference (inches)

Small	18-22 cm	7-9 in
Medium	23-25 cm	9-10 in
Large	26-28 cm	10-11 in
Extra Large	29-32 cm	11.5-13 in

BABY WRAPS

PATTERNED FLANNELETTE BABY WRAPS



Premium soft cotton, highly absorbent and quick drying baby wraps for hospital use. Available in 2 prints.

- 100% premium cotton flannelette
- 2 print designs available
- Suitable for laundering at thermal disinfection temperatures

Patterns available



Hospital Use Only



Nursery

Product name	Size	Code
Flannelette baby wrap	One size: 75cm x 100cm	ST815

COTTON FLANNELETTE BABY WRAPS



Premium soft cotton, highly absorbent and quick drying baby wraps for hospital use. 100% premium cotton flannelette material.

- Suitable for laundering at thermal disinfection temperatures
- Size: 86cm x 112cm
- Available in white only

Product name	Size	Code
Cotton flannelette baby wrap	One size: 86cm x 112cm	ST803

You might also like



Baby blankets on pg. 10



Baby hooded towels on pg. 21

Next day dispatch on all stocked baby wraps to UK mainland addresses. Simply buy online before 3:30pm*.

*Weekdays only



SECLUSION WEAR

SECLUSION GOWN



Used in mental health facilities, custody centres and high risk security units, these gowns are made from Secure-Tex fabric. Designed to assist with the prevention of self-harm.

- Fabric is flame retardant, dual-layered and channel stitched.
- Suitable for laundering at thermal disinfection temperatures
- For use in combination with supervision

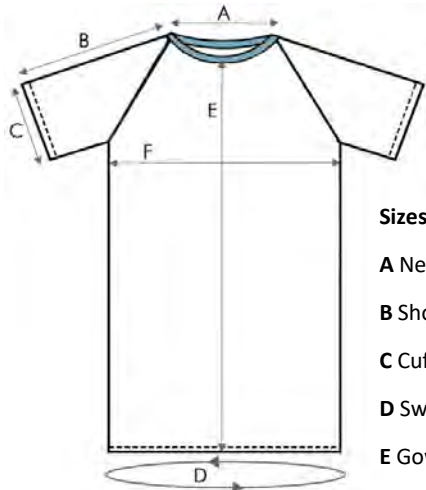

Sizes (cm)	XS	S	M	L	XL	XXL	3XL
A Neck circumference	49	49	60	65	72	74	76
B Shoulder & arm length	26	28	32	36	40	45	50
C Cuff circumference	51	51	56	56	56	56	56
D Sweep	122	131	154	176	191	200	209
E Gown length	108	109	109	115	115	117	120
F Chest circumference	104	112	129	150	166	184	194

Product name	Size	Code
Seclusion gown	XS – 3XL	PG950

SECLUSION TROUSERS

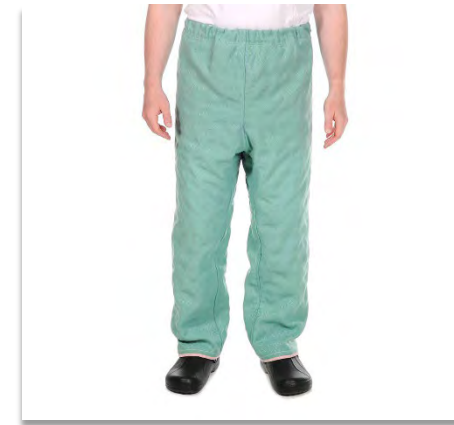

These trousers are made from Secure-Tex fabric and worn with either a tunic or gown in mental health facilities, custody centres and high risk security units. 6-part elasticated waistband. Designed to assist with the prevention of self-harm.

- Fabric is flame retardant, dual-layered and channel stitched.
- Suitable for laundering at thermal disinfection temperatures
- For use in combination with supervision

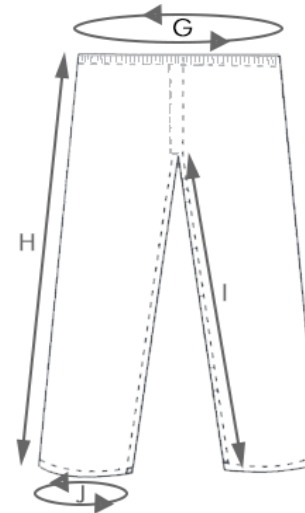

Sizes (cm)	XS	S	M	L	XL	XXL	3XL
G Waist circumference	91	101	109	121	137	147	157
H Length	105	118	118	123	132	132	132
I Hips	94	102	110	120	132	142	152
J Trouser cuff circumference	38	43	48	53	58	63	68

Product name	Size	Code
Seclusion trousers	XS – 3XL	PG952

SECLUSION WEAR

SECLUSION TUNIC

Secure-Tex tunics to be worn with seclusion trousers or shorts for use in mental health facilities, custody centres and high risk security units.

- Fabric is flame retardant, dual-layered and DNA quilt stitched
- Suitable for laundering at thermal disinfection temperatures
- For use in combination with supervision



SECLUSION SHORTS

Heavyweight shorts made from Secure-Tex fabric, with reinforced stitching to avoid ripping. 6-part elasticated waistband. To be worn with seclusion tunic for use in mental health facilities, custody centres and high risk security units.

- Fabric is flame retardant, dual-layered and DNA quilt stitched.
- Suitable for laundering at thermal disinfection temperatures
- For use in combination with supervision

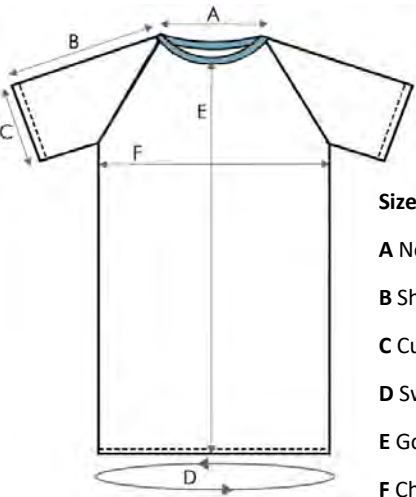

Sizes (cm)	XS	S	M	L	XL	XXL	3XL
A Neck circumference	49	49	60	65	71	74	76
B Shoulder & arm length	24	28	32	36	40	45	50
C Cuff circumference	51	51	56	56	56	56	56
D Sweep	122	131	154	176	191	200	209
E Gown length	80	80	85	86	86	88	91
F Chest circumference	104	112	129	150	166	184	194

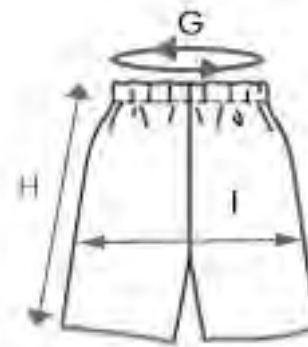

Sizes (cm)	XS	S	M	L	XL	XXL	3XL
G Waist circumference	91	101	109	121	137	147	157
H Length	59	62	68	73	78	82	94
I Hips	94	102	110	120	132	142	152

Product name	Size	Code
Seclusion tunic	XS – 3XL	PG951

Product name	Size	Code
Seclusion shorts	XS – 3XL	PG953

PATIENT COMFORT

SHEEPSKIN HEEL PROTECTORS



Pure wool sheepskin heel protectors with soft adjustable Velcro straps. The pure wool fleece with small openings at each side and back of the foot ensures comfort & breathability.

- Machine washable up to 40 degrees
- For use in bed or when sitting
- Suitable for all ankle sizes

Product name	Size	Code
Sheepskin heel protectors	One size	PR001

BED WEDGE PILLOW



This pillow raises the user slightly in bed, helping sufferers of acid reflux, hiatal hernia and GERD. It can also help snorers by opening airways. Featuring a foam inner and flame retardant cover.

- Washable cotton cover which zips off
- Foam wedge pillow
- Size: 61cm x 61cm

Product name	Size	Code
Bed wedge pillow	One size	PR010

PADDED WHEELCHAIR CUSHION



The padded wheelchair cushion is a standard size, covering the backs and arms of the wheelchair. Features a wipe clean cover.

- Wipe clean cover
- Easily foldable to travel with
- Fits most standard size wheelchairs

Product name	Size	Code
Padded wheelchair cushion set	96cm x 42cm	PR014

COOLING MATTRESS TOPPER



Ideal for hot sleepers who may experience temperature related discomfort during sleep. E.g hot flushes or night sweats. Suitable for single beds.

- Machine washable at 40 degrees
- Comfortable cooling layer
- Elasticated straps

Product name	Size	Code
Cooling mattress topper	94cm x 90cm	MP040

SLIDE SHEETS – PATIENT SPECIFIC

ELITE PATIENT SPECIFIC FLAT SLIDE SHEETS



Slide sheets allow easy ultra low friction patient movement whilst reducing risk of injury to both carers and patients.

- 100cm x 200cm
- 140cm x 200cm
- 71cm x 200cm
- 90cm x 90cm
- 90cm x 135cm

Product name	Size	Code	Supply chain code
Elite patient specific slide sheet	100cm x 200cm	PH020100200---REDA62	TLC686
Elite patient specific slide sheet	140cm x 200cm	PH020140200---REDA62	N/A
Elite patient specific slide sheet	71cm x 200cm	PH020-71-200---REDA62	N/A
Elite patient specific slide sheet	90cm x 90cm	PH020-90-90---REDA62	FES10778
Elite patient specific slide sheet	90cm x 135cm	PH020-90135---REDA62	FES10759

ELITE PATIENT SPECIFIC SLIDE SHEET WITH HANDLES



Slide sheets allow easy ultra low friction patient movement whilst reducing risk of injury to both carers and patients. With handles.

- 90cm x 200cm
- 148cm x 220cm
- 140cm x 200cm
- 71cm x 200cm

Product name	Size	Code	Supply chain code
Elite patient specific slide sheet w/ handles	90cm x 200cm	PH023-90200---REDA62	VTS094
Elite patient specific slide sheet w/ handles	148cm x 220cm	PH023148220---REDA62	TLC688
Elite patient specific slide sheet w/ handles	140cm x 200cm	PH023140200---REDA62	N/A
Elite patient specific slide sheet w/ handles	71cm x 200cm	PH023-71200---REDA62	N/A

Next day dispatch on all stocked products to UK mainland addresses. Simply buy online before 3:30pm*.

*Weekdays only



Have you seen the slide sheet bag?

Keep your slide sheets safe and close to the patient with a handy slide sheet bag.

View on pg. 48



SLIDE SHEETS – PATIENT SPECIFIC

PATIENT SPECIFIC TUBULAR SLIDE SHEETS



Slide sheets allow easy low friction patient movement whilst reducing risk of injury to both carers and their patients. Reduce back injury risk.

- 71cm x 145cm
- 71cm x 122cm
- 100cm x 122cm
- 70cm x 100cm
- 41cm x 60cm
- 71cm x 72cm

Product name	Size	Code	Supply chain code
Patient specific tubular slide sheet	71cm x 145cm	PH420-71145---REDA06	N/A
Patient specific tubular slide sheet	71cm x 122cm	PH420-71122---REDA06	N/A
Patient specific tubular slide sheet	100cm x 122cm	PH420100122---REDA06	N/A
Patient specific tubular slide sheet	70cm x 100cm	PH420-70100---REDA06	N/A
Patient specific tubular slide sheet	41cm x 60cm	PH420-41-60---REDA06	N/A
Patient specific tubular slide sheet	71cm x 72cm	PH420-71-72---REDA06	N/A

ELITE PATIENT SPECIFIC TUBULAR SLIDE SHEETS



Slide sheets allow easy ultra low friction patient movement whilst reducing risk of injury to both carers and patients.

- 100cm x 200cm
- 140cm x 200cm
- 71cm x 200cm
- 90cm x 135cm
- 120cm x 150cm
- 90cm x 90cm

Product name	Size	Code	Supply chain code
Elite patient specific slide sheet	100cm x 200cm	PH020100200---REDA62	TLC686
Elite patient specific slide sheet	140cm x 200cm	PH020140200---REDA62	N/A
Elite patient specific slide sheet	71cm x 200cm	PH020-71-200---REDA62	N/A
Elite patient specific slide sheet	90cm x 90cm	PH020-90-90---REDA62	FES10778
Elite patient specific slide sheet	90cm x 135cm	PH020-90135---REDA62	FES10759

Next day dispatch on all stocked products to UK mainland addresses. Simply buy online before 3:30pm*.

*Weekdays only



SLIDE SHEETS - REUSABLE

ELITE RE-USABLE FLAT SLIDE SHEETS



Durable, re-usable slide sheets allow easy ultra low friction patient movement whilst reducing injury risk to carer and patient. Launderable to thermal disinfection temperatures.

- 75cm x 200cm
- 100cm x 200cm
- 140cm x 200cm

Product name	Size	Code	Supply chain code
Elite re-usable flat slide sheet	75cm x 200cm	PH007-75200---TEAA77	N/A
Elite re-usable flat slide sheet	100cm x 200cm	PH007100200---TEAA77	FES10783
Elite re-usable flat slide sheet	140cm x 200cm	PH007140200---TEAA77	TLC562

Have you seen patient transfer sheets?



Go to pg. 49

ELITE RE-USABLE TUBULAR SLIDE SHEETS



Durable, re-usable tubular slide sheets allow easy ultra low friction patient movement while reducing injury risk.

- 41cm x 60cm 71cm x 200cm
- 71cm x 72cm 75cm x 200cm
- 70cm x 100cm 100cm x 122cm
- 71cm x 122cm 100cm x 200cm
- 71cm x 145cm 90cm x 90cm
- 90cm x 135cm 140cm x 200cm

Product name	Size	Code	Supply chain code
Elite re-usable tubular slide sheet	140cm x 200cm	PH407140200---TEAA77	TLC691
Elite re-usable tubular slide sheet	71cm x 72cm	PH407-71-72---TEAA77	N/A
Elite re-usable tubular slide sheet	71cm x 145cm	PH407-71145---TEAA77	N/A
Elite re-usable tubular slide sheet	71cm x 122cm	PH407-71122---TEA77	N/A
Elite re-usable tubular slide sheet	100cm x 122cm	PH407100122---TEA77	N/A
Elite re-usable tubular slide sheet	100cm x 200cm	PH407100200---TEA77	TLC690
Elite re-usable tubular slide sheet	90cm x 135cm	PH407-90135---TEA77	FES10765
Elite re-usable tubular slide sheet	90cm x 90cm	PH407-90-90---TEA77	FES10784
Elite re-usable tubular slide sheet	75cm x 200cm	PH407-75200---TEA77	N/A
Elite re-usable tubular slide sheet	71cm x 200cm	PH407-71200---TEA77	N/A
Elite re-usable tubular slide sheet	70cm x 100cm	PH407-70100---TEA77	N/A
Elite re-usable tubular slide sheet	41cm x 60cm	PH407-41-60---TEA77	N/A

SLIDE SHEETS - REUSABLE

ELITE RE-USABLE FLAT SLIDE SHEETS WITH HANDLES



Durable, re-usable slide sheets with handles allow easy ultra low friction patient movement with greater control whilst reducing risk of injury to both carers and patients. Launderable to thermal disinfection temperatures.

- 72cm x 200cm
- 100cm x 200cm
- 140cm x 200cm

Product name	Size	Code	Supply chain code
Elite re-usable slide sheet w/ handles	72cm x 200cm	PH017-72200---TEAA77	N/A
Elite re-usable slide sheet w/ handles	100cm x 200cm	PH017100200---TEAA77	VTS210
Elite re-usable slide sheet w/ handles	140cm x 200cm	PH017140200---TEAA77	VTS211

SLIDE SHEET BAG



Red polyester bag with webbing drawstring handle is useful for storing slide sheets on the hospital ward or in care homes.

- Used to store slide sheets
- Strong webbing drawstring handle
- Available in red

Product name	Size	Code
Slide sheet bag	20cm x 33cm	PH810

Next day dispatch on all stocked products to UK mainland addresses. Simply buy online before 3:30pm*.

*Weekdays only



Take a look at patient handling accessories



Go to pg. 51

PATIENT TRANSFER SHEETS

TRANSFER SHEETS



Slidetex patient transfer sheet with 6 handles down each side. Used by hospital staff when moving patients. Disposable, not launderable.

- 200kg weight capacity
- Water repellent
- 6 ergonomic handles each side
- Latex free & non slippery

Product name	Size	Code	Supply chain code
Transfer sheet	85cm X 194cm	PH700	VTS114
Transfer sheet	110cm x 194cm	PH700	TLC143

SUPA SLIDE PATIENT SPECIFIC FLAT SLIDE SHEETS



Non-woven polypropylene disposable slide sheets are used by hospitals, clinics, nursing homes and more. Boxes of 100 slide sheets.

- 75cm x 200cm (standard size)
- 100cm x 200cm (bariatric size)

Product name	Size	Code	Supply chain code
SUPA slide sheets	2 sizes	PH025	VTS200

IPACKS



The iPacks consist of clear plastic bag with drawstring containing two large slide sheets for patient moving and handling.

- Silicon coated polyester
- Available in red or yellow
- 100% polyester material



Product name	Size	Code
iPack red & red	100cm x 200cm	PH515
iPack red & yellow	100cm x 200cm	PH516
iPack red & red	140cm x 200cm	PH517

AIRPAL PATIENT TRANSFER SYSTEM

PATIENT SPECIFIC MATTRESS



Patient specific Airpal transfer pads are used with the Airpal patient transfer system. Wipe clean mattress pads.

- Specialized latex-free 4 way stretch layered medical fabric
- Long extension handles
- Safe working limit of 454kg (70 stones)

Product name	Size	Code
Airpal patient specific mattress	86cm x 198cm	AP020

RE-USABLE MATTRESS



The Airpal mattress is used by nurses and caregivers to perform a lateral transfer of a patient from one horizontal position to another. Specialized medical fabrics with cushioned platform.

- Launderable
- Compatible with X-ray and MRI
- Nickel plated brass snaps
- Safe working limit of 454kg (70 stones)

Product name	Size	Code
Airpal re-usable mattress	86cm x 198cm	AP000

AIR SUPPLY



To be used with an Airpal patient transfer mattress to move hospital patients laterally.

The air supply powers the patient transfer with a high volume and low-pressure source of airflow.

Product name	Size	Code
Air supply	One size	AP300

MATTRESS COVER



Mattress sani liner covers for the 86cm Airpal patient transfer mattress are available to buy online.

These launderable sani liner covers protect the Airpal re0usable mattress from spills and accidental marking.

Product name	Size	Code
Airpal mattress cover	86cm x 198cm	AP100

PATIENT HANDLING ACCESSORIES

SLIDE SHEET EXTENSION



Extension straps are attached to slide sheets with handles to allow nurses and carers to avoid overreaching, injuries and give greater control.

- Extend reach by 90cm
- Easy loop attachment
- Handle loop for secure handling
- Launderable & reusable
- 300kg breaking strain per strap

Product name	Size	Code
Slide sheet extension	1.9cm long	PH800

SLIDETEX GLOVES



Assists nurses and carers with patient movement and comfort, removing uncomfortable creases from bedlinen and clothing by smoothing down.

- One size fits all
- 65gsm nylon with silicone coating
- 75cm x 20cm

Product name	Size	Code	Supply chain code
Slidetex gloves	75cm x 20cm	PH803	EVX503

STOCKING SLIDER



Putting open-toe compression stockings on patients becomes easy and quick with a stocking slider. Reduces friction. Stocking slider fabric is patient specific.

- Use with open toe compression socks
- Use with closed toe socks when inspection hole present
- Can assist with compression sleeves

Product name	Size	Code
Stocking slider	70cm x 22cm	PH802

BED LADDER STRAP



Assists patients in sitting up in bed by themselves, the bed ladder strap is made of strong fabric webbing. Easily fits to the bed.

- 100% strong polyester webbing
- 1.9 metres long
- 5 handholds and a bed attachment loop

Product name	Size	Code
Bed ladder strap	1.9m long	PH801

STAFF PROTECTION (PPE)

REUSABLE FACE MASKS



Breathable high-quality mask is 3-ply, made with 2 outer layers of cotton and an inner layer of polyester mesh lining. Outer layer has Silvadur 930 Flex antibacterial treatment.

- One size fits all - elastic ear loops
- 3-ply masks
- Machine washable at 60 degrees

Product name	Size	Code
Reusable face masks (individual)	17cm x 12cm	FP100

KN95 FACE MASKS



Face masks can be worn to protect staff from viral and bacterial microbes. These masks have a 4-layer structure which provides a filtering effect of 95% minimum.

- Two ear loops
- Provided in packs of 10
- KN95 is the equivalent of FFP2 European regulation

Product name	Size	Code
NK95 face masks (pack of 10)	16.5cm x 10.5cm	DP300

DISPOSABLE 3-PLY TYPE II FACE MASKS



Blue and white 3-ply Type II disposable face masks for used as a face covering. Ideally worn when 2m distance can't be maintained.

- Provided in packs of 50
- Flexible nose bar for better protection
- Bacterial filtration efficiency (BFE) > 98%
- Complies with EN14683; 2019

Product name	Size	Code
Disposable face masks (pack of 50)	17.5cm x 9.5cm	DP322

Next day dispatch on all stocked products to UK mainland addresses. Simply buy online before 3:30pm*.

*Weekdays only



STAFF PROTECTION (PPE)

POLYTHENE COVERALL APRONS



Disposable polythene coverall aprons, can be worn over usual staff uniform or scrubs for protection against fluids and bacterial penetration.

- 19 Micron count
- Apron measures 77cm by 105cm
- Provided in packs of 50
- Easy rip to remove
- White aprons
- Full front and back torso coverage

Product name	Size	Code
Polythene coverall aprons (pack of 50)	77cm x 105cm	DP200-77100---WHTV58

SPLASH PROOF FACE SHIELDS



Transparent medical face shield protects the entire face when worn with a face mask. Anti-fog coating prevents misting.

- One size fits all - elastic headband
- Splash proof
- Anti fog
- Wipeable & re-usable
- Protects face from coughs and sneezes

Product name	Size	Code
Face shields (individual)	29cm x 24.5cm	FP000-29-24---CLR28

Next day dispatch on all stocked products to UK mainland addresses. Simply buy online before 3:30pm*.

*Weekdays only



SHOWER CURTAINS

WHITE SHOWER CURTAINS



Shower curtains with weighted hems and non-rusting eyelets are used extensively in hospitals and nursing homes.

To fit the shower curtains, simply hook the curtain eyelets onto the existing hooks on the shower curtain rail.

- 100% polyester material
- Machine washable
- 180cm wide x 180cm long
- 180cm wide x 200cm long

Product name	Size	Code
Shower curtains - white	2 sizes	SH005

Do you buy towels?



14 COLOURS AVAILABLE



Turn to pg. 21 to see more

Next day dispatch on all stocked products to UK mainland addresses. Simply buy online before 3:30pm*.

*Weekdays only



LAUNDRY BAGS

POLYTHENE LAUNDRY BAGS



Polythene plastic laundry bags are used in most NHS hospitals, as well as in care homes, salons and clinics.

Whenever there is a need to transport fouled or infected linen to the laundry, these plastic bags are more hygienic and safer than using fabric equivalents.

Coloured coded for easy identification. Available in red to signify fouled, infected or biohazardous linen, also available in white and green.

- Boxes of 500 bags
- Size: 72cm x 100cm
- Red, green and white colours



Product name	Size	Code
Polythene laundry bags (50 bags)	72cm x 100cm	LB500-72100

LAUNDRY BAG WITH WEBBING LOOP



Hospital laundry bags are used in hospitals and clinics to transport soiled linen hygienically to the laundry.

- Elasticated opening at the top is designed to be wide enough to fit most laundry collection trolleys
- 100% polyester material
- Red, white, and green colours

Product name	Size	Code
Laundry bag with webbing loop	83cm x 147cm	LB002-83147

Are you stocked up on PPE?



See PPE on pg. 52-53



Contact details

Tel: 01422 372333

Email: sales@interweavetextiles.com

Web: www.interweavetextiles.com

Opening hours

Monday to Friday 8:30am to 5pm Closed Public Holidays

Address

Interweave House, Old Power Way, Elland, West Yorkshire, HX5 9DE, UK