



PRODUCT CATALOGUE
2022

interweave
healthcare

CONTENTS

BEDDING

| | |
|---------------------|-------|
| Polycotton | 3 |
| Cotton rich | 4 |
| Interfit | 5 |
| Fire retardant | 6 |
| Easycare polycotton | 7 |
| Non woven | 8 |
| Thermal throws | 9 |
| Blankets | 10-11 |
| Pillows & duvets | 12-14 |
| Mattress protection | 15-16 |
| Seclusion | 17 |

TOWELS

| | |
|--------------------|----|
| Hospital towels | 19 |
| Plain white towels | 19 |
| Coloured towels | 20 |
| Baby towels | 20 |
| Kitchen linen | 21 |

SCRUB SUITS

| | |
|-------------------------|-------|
| Performance scrubs | 22-23 |
| Mortician gown | 23 |
| WonderWORK scrubs | 24-25 |
| Scrub cap & accessories | 26 |

PATIENT WEAR

| | |
|-------------------|-------|
| Adult gowns | 27-29 |
| Bariatric gowns | 30 |
| Dressing gowns | 31 |
| Mammogram cape | 32 |
| Interfaith gowns | 33 |
| Child gowns | 34 |
| Nightwear | 35-36 |
| Slipper socks | 37 |
| Compression socks | 38 |
| Baby wraps | 39 |
| Seclusion wear | 40-41 |

PATIENT HANDLING

| | |
|-----------------|-------|
| Patient comfort | 42 |
| Slide sheets | 43-46 |
| Transfer sheets | 46 |
| iPacks | 46 |
| Patient lifting | 48 |
| Accessories | 49 |

PPE

| | |
|----------------------|-------|
| Face masks & shields | 50-51 |
| Aprons | 51 |

CURTAINS

| | |
|-----------------|----|
| Shower curtains | 52 |
|-----------------|----|

LAUNDRY BAGS

| | |
|--------------|----|
| Laundry bags | 53 |
|--------------|----|

Interweave Healthcare, to help you care

Specialising in supplying healthcare products and patient handling products to hospitals, private clinics and nursing homes.

Trusted by healthcare professionals, laundry managers and business owners, buy online to benefit from:

- Credit card payments online
- Free UK mainland delivery for orders over £50
- Next day delivery for orders placed before 1pm *
- Delivery to private or commercial addresses

* Next day delivery to UK mainland available on most items

KEY FEATURES



New product
added this year



Best selling
product in the range



Product we love,
handpicked by us



Product in
several colours



Flame
retardant product



Water resistant
product

POLYCOTTON BEDDING

POLYCOTTON SHEETS



Hard-working polycotton flat sheet to fit single beds. Ideal for hospital or nursing home use. Longer than domestic flat sheets to fit hospital bed.

- Suitable for laundering at thermal disinfection temperatures
- 130gsm weight

| Product name | Size | Code | Supply chain code |
|---|---------------|-------------|-------------------|
| Polycotton flat sheet - single bed | 178cm x 275cm | ST010180275 | VCS026 |
| Polycotton flat sheet - cot | 86cm x 112cm | ST810-86112 | N/A |
| Polycotton flat sheet – single bed extra long | 178cm x 300cm | ST010180300 | N/A |

POLYCOTTON EASYCARE FLAT SHEETS



Easycare polycotton sheet for both single and double beds. Available in white or cream. Flat bed sheets are ideal for us in nursing, & residential homes or domestic use.

- Washable at 50 degrees and needs minimal ironing
- Available in two neutral colours

| Product name | Size | Code |
|---|---------------|-------------|
| Polycotton easycare flat sheet – single | 180cm x 255cm | ST000180255 |
| Polycotton easycare flat sheet - double | 228c x 255cm | ST000228255 |

POLYCOTTON PILLOWCASES



Polycotton pillowcases are durable, comfortable and practical. Ideal for hospitals, nursing homes and other healthcare facilities.

- Suitable for laundering at thermal disinfection temperatures
- Larger than domestic pillowcases

| Product name | Size | Code | Supply chain code |
|---------------------------------------|-------------|-------|-------------------|
| Polycotton housewife style pillowcase | 55cm x 75cm | PC010 | N1207519 |

POLYCOTTON DUVET COVERS



Single bed polycotton duvet covers for nursing homes & other institutions. Comfortable, durable and neutral colours available.

- Matching pillowcases available
- Matching fitted sheets available
- Available in white or cream

| Product name | Size | Code |
|-------------------------------------|---------------|-------------|
| Polycotton duvet cover – single bed | 137cm x 198cm | DC400137198 |
| Polycotton duvet cover – double bed | 198cm x 198cm | DC400198198 |

COTTON RICH BEDDING

COTTON RICH SHEETS



Cotton flat sheet to fit single beds, extra long single beds and cots. Ideal for hospital or nursing home use. Longer than domestic flat sheets to fit hospital beds. 130gsm weight.

- Hospital quality bed linen
- Suitable for laundering at thermal disinfection temperatures

| Product | Size | Code |
|--|---------------|-------------|
| Cotton rich flat sheet - single bed | 180cm x 275cm | ST075180275 |
| Cotton rich flat sheet - single bed extra long | 180cm x 300cm | ST070180300 |
| Cotton rich flat sheet - cot | 86cm x 115cm | ST824-86115 |

You might also like



Elite thermal throw pg. 9

COTTON RICH PILLOWCASES



Popular cotton rich hospital-quality pillowcases are highly durable & comfortable. Larger size for ease of fitting. Durable and comfortable fabric.

- Fabric weight 130gsm
- Suitable for laundering at thermal disinfection temperatures

| Product name | Size | Code |
|--|-------------|-------|
| Cotton rich housewife style pillowcase | 55cm x 75cm | PC075 |
| Cotton rich bag style pillowcase | 51cm x 85cm | PC475 |

You might also like



Lap blankets pg. 9

INTERFIT BEDDING

INTERFIT FITTED SHEETS



Hard-wearing polycotton elasticated fitted sheet for single beds. Customer favourite for its no creasing.

- Fabric with flexible stretch
- Fits all healthcare mattresses
- Suitable for laundering at thermal disinfection temperatures

| Product name | Size | Code |
|--|------------|-------|
| Interfit knitted fitted sheet | Single bed | ST426 |
| Interfit knitted semi-fitted top sheet | Single bed | ST427 |

INTERFIT FITTED PILLOWCASES



Durable hospital-quality polycotton pillowcases with four stretch fabric. No ironing needed with easycare fabric.

- Full bedding range
- Suitable for laundering at thermal disinfection temperatures
- Extra stretchy material

| Product name | Size | Code |
|------------------------------------|-------------|-------|
| Interfit knitted fitted pillowcase | 46cm x 69cm | PC025 |



LAUNDRER HOT
For thermal disinfection,
after every use



FOUR WAY STRETCH
Only takes one person
to make a bed



EASYCARE
No creases, minimises
pressure sores



FULL BEDDING RANGE
Maximum patient comfort

FIRE RETARDANT BEDDING

FIRE RETARDANT SHEETS



Used by hospitals and nursing homes. BS7175 fire retardant polyester remains effective even after laundering.

- 100% FR polyester
- Double bed sheets in cream or white
- Hospital-grade bed linen

| Product name | Size | Code |
|------------------------------|---------------|--------------|
| FR Flat sheet – single bed | 180cm x 255cm | ST001180255 |
| FR Flat sheet – double bed | 228cm x 255cm | ST0001228255 |
| FR Fitted sheet – single bed | 90cm x 90cm | ST400-90190 |
| FR Fitted sheet – double bed | 137cm x 190cm | ST401137190 |

Colours available for single bedding / pillowcases



Double size

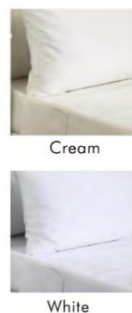

FIRE RETARDANT PILLOWCASES

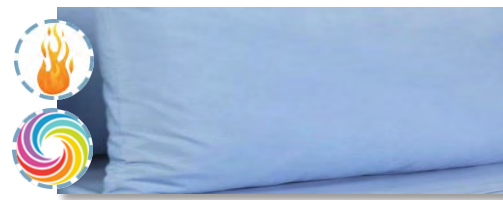

Pillowcases designed for hospitals & nursing homes in FR polyester. Complies with BS7175. Comfortable, practical and safe. Available in 10 colours.

| Product name | Size | Code |
|---|-------------|-------|
| FR polyester housewife style pillowcase | 50cm x 75cm | PC001 |

FIRE RETARDANT V-SHAPED PILLOWCASES



Pillowcases designed to fit the Interweave V-shaped pillow in FR polyester. Available in white. Machine washable at 60 degrees.

| Product name | Size | Code |
|---------------------------|--------------|-------|
| FR polyester V pillowcase | 73cm x 114cm | PC801 |

FIRE RETARDANT DUVET COVERS

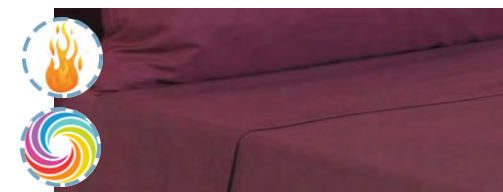

Fire retardant polyester duvet covers with matching bedding available. Double size available in cream or white.

| Product name | Size | Code |
|-----------------------------|---------------|-------|
| FR duvet cover – single bed | 137cm x 198cm | DC401 |
| FR duvet cover – double bed | 200cm x 200cm | DC401 |

EASYCARE POLYCOTTON BEDDING

EASYCARE POLYCOTTON SHEETS



Easycare polycotton bed sheets to fit single beds. Ideal for hospital or nursing home use. Hospital quality bed linen.

- Suitable for laundering at thermal disinfection temperatures
- 130gsm weight

| Product name | Size | Code |
|---|---------------|-------------|
| Easycare polycotton flat sheet – single bed | 180cm x 255cm | ST000180255 |
| Easycare polycotton flat sheet – double bed | 228cm x 255cm | ST000228255 |
| Easycare polycotton fitted sheet – single bed | 90cm x 190cm | ST400-90190 |
| Easycare polycotton fitted sheet – double bed | 137cm x 190cm | ST400137190 |

You might also like



Polyester cellular blankets pg. 10

DUVET COVERS



Single bed easycare polycotton duvet covers for nursing homes & other institutions. Comfortable and durable.

- Suitable for laundering at thermal disinfection temperatures
- Matching bedding available

| Product name | Size | Code |
|--|---------------|-------------|
| Easycare polycotton duvet cover – single | 137cm x 198cm | DC400137198 |
| Easycare polycotton duvet cover - double | 198cm x 198cm | DC400198198 |

EASYCARE POLYCOTTON PILLOWCASES



Easycare polycotton pillowcases are durable, comfortable and practical. Ideal for hospitals, nursing homes and other healthcare use.

- Suitable for laundering at thermal disinfection temperatures
- Available in white or cream

| Product name | Size | Code |
|--------------------------------|-------------|-------|
| Easycare polycotton pillowcase | 50cm x 75cm | PC000 |

NON-WOVEN DISPOSABLE BEDDING

NON-WOVEN DISPOSABLE SHEETS



Cost effective bedding solution for hospitals, clinics, salons and dentists. Nonwoven polypropylene disposable flat sheets to fit single beds.

- Ideal for contingency planning
- Ideal when no laundry facilities available

| Product name | Size | Code |
|---|---------------|-------|
| Disposable non-woven sheet - single bed | 140cm x 229cm | ST033 |

NON-WOVEN DISPOSABLE PILLOWCASES



Cost effective bedding solution for hospitals, clinics, salons and dentists. Nonwoven polypropylene disposable flat sheets to fit single beds.

- Ideal for contingency planning
- Ideal when no laundry facilities available

| Product name | Size | Code |
|--------------------------------------|-------------|-------|
| Non-woven pillowcase housewife style | 51cm x 76cm | PC033 |

Have you seen these compression socks?



Available in four sizes, see pg. 38



THERMAL THROWS

PREMIUM THERMAL THROW



Thermal throw blanket for single beds available in 2 colours. 100% polyester material.

- Complies with BS EN 12952
- Suitable for laundering at thermal disinfection temperatures



| Product name | Size | Code |
|---------------------------|---------------|-------|
| Premium throw- single bed | 180cm x 255cm | BK554 |

ELITE THERMAL THROW



Polyester thermal blankets ideal for hospitals, nursing homes & rehabilitation centres. Single bed size available in 6 colours.

- Cot size available in cream – colours buy request
- Flame retardancy complies with BS EN 12952

| Product name | Size | Code |
|--------------------------|---------------|-------------|
| Elite throw – single bed | 168cm x 210cm | BK555168210 |
| Elite throw - cot | 86cm x 102cm | BK555-86102 |

Colours: Elite thermal throws & lap blankets

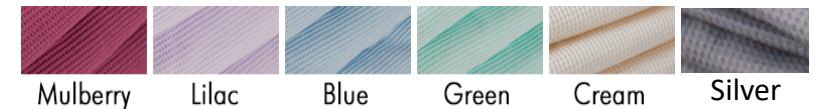

HEAVYWEIGHT THROW



Thermal throw blanket for single beds. Ideal for nursing homes, hospitals and rehabilitation centres. Flame retardant with BS EN 12952.

- 100% polyester material
- Available in blue

| Product name | Size | Code |
|--------------------------------|---------------|-------|
| Heavyweight throw – single bed | 180cm x 210cm | BK559 |

LAP BLANKETS



Designed to keep the lap and all around the legs warm whilst sitting. Ideal for care & nursing homes.

- Flame retardancy complies with BS EN 12952
- Large and small sizes available

| Product name | Size | Code |
|----------------------|---------------|-------------|
| Lap blankets – small | 80cm x 102cm | BK555-80102 |
| Lap blankets - large | 102cm x 168cm | BK555102168 |

BLANKETS

POLYESTER CELLULAR BLANKETS



Easycare and comfortable. Used in various healthcare facilities. Single bed size are available in 5 colours. Cot blankets available online in 5 colours.

- 100% polyester fabric
- Cellular weave suitable for all seasons
- Flame retardant to BS7175

| Product name | Size | Code | Supply chain code |
|--|---------------|-------------|-------------------|
| Polyester cellular baby blanket - white | 80cm x 102cm | BK250-80102 | N/A |
| Polyester cellular baby blanket - coloured | 80cm x 102cm | BK250-80102 | N/A |
| Polyester cellular single bed blanket | 165cm x 210cm | BK250165210 | N1207511 |

Colours available for single bed & baby blankets



White Magnolia Maize Green Blue

Same day dispatch on all stocked blankets to UK mainland addresses. Simply buy online before 1pm*.

*Weekdays only



COTTON CELLULAR BLANKETS (BABY)



Soft & comfortable, easycare white cellular blankets for cribs and cots. Keeps babies warm in winter & comfortable in summer.

- Cellular weave for all seasons
- Used in maternity units, birthing centres and day nurseries

| Product name | Size | Code |
|--------------------------------------|--------------|-------------|
| Cotton cellular crib blanket - white | 73cm x 86cm | BK200-73-86 |
| Cotton cellular cot blanket - white | 86cm x 112cm | BK200-86112 |

WHITE SINGLE BED BLANKETS



Comfortable cotton white cellular blankets for single beds. Used by hospitals, nursing homes and local authorities. Washable at high temperatures.

- Cellular weave for all seasons
- Min order quantity: 25
- 100% soft cotton fabric

| Product name | Size | Code | Supply chain code |
|--|---------------|-------------|-------------------|
| Cotton cellular single bed blanket - white | 170cm x 228cm | BK200178228 | N1207510 |

BLANKETS & BEDSPREADS

TRELLIS FIRE RETARDANT BEDSPREADS



Flame retardant polyester counterpanes add weight and warmth to bedding. Used in nursing homes & hospitals.

- 100% polyester fabric
- Complies with FR regulation BS7175

| Product name | Size | Code | Supply chain code |
|--------------------------------|---------------|-------------|-------------------|
| Trellis bedspread – single bed | 180cm x 230cm | BS020180230 | N1207509 |

Colours available



Blue

Cream

Green

Lilac

Same day dispatch on all blankets to UK mainland addresses. Simply buy online before 1pm.



POLAR FLEECE BLANKETS



Soft and comfortable, tan polar fleece single bed blankets used by hotels, nursing homes and other institutions for added warmth.

- 100% knitted polyester material
- Available in tan only

| Product name | Size | Code |
|-------------------------------------|---------------|-------------|
| Polar fleece blanket tan – single | 180cm x 230cm | BK828180230 |
| Polar fleece blanket tan - double | 230cm x 230cm | BK828230230 |
| Polar fleece blanket tan - kingsize | 230cm x 275cm | BK828230275 |

AMBULANCE BLANKETS



100% polyester ambulance blanket, essential item in first aid kits. Re-usable and launderable at thermal disinfection temperatures.

- Available in Mulberry red
- Durable fabric

| Product name | Size | Code |
|-------------------|---------------|-----------|
| Ambulance blanket | 168cm x 210cm | BK555-MUL |

PILLOWS

FIRE RETARDANT WIPE CLEAN “GREEN TINT” PILLOWS



Medical grade pillows used on hospital wards, in nursing homes & by local authorities. Lightweight & practical pillow.

- Compliant with BS7175 Source 5
- Polypropylene filling
- Made in the UK

| Product name | Size | Code |
|----------------------------------|-------------|-------|
| FR Wipe clean green tint pillows | 46cm x 69cm | PW027 |

FIRE RETARDANT HOLLOWFIBRE PILLOWS



Flame retardant hollowfibre pillows used in hospitals and nursing homes. Fire retardant cover – complies with BS7175 Source 5.

- Proban treated material
- Weighs 500g
- Made in the UK

| Product name | Size | Code |
|------------------------|-------------|-------|
| FR hollowfibre pillows | 45cm x 68cm | PW005 |

HOLLOWFIBRE PILLOWS



Long lasting hollowfibre ensures these pillows are comfortable yet durable. Ideal for hospitals and nursing homes for comfort.

- Comfortable hollowfibre pillow
- Pillow weighs 450g
- Made in the UK

| Product name | Size | Code |
|---------------------|-------------|-------|
| Hollowfibre pillows | 45cm x 68cm | PW003 |

FIRE RETARDANT WATERPROOF PILLOWS



Used by hospitals, nursing homes and local authorities. Flame retardant wipe clean polyester hollowfibre pillows.

- Compliant with BS7175 Source 5
- Ultra high frequency welded seams
- Made in the UK

| Product name | Size | Code |
|---------------------------------|-------------|-------|
| FR wipe clean polyester pillows | 48cm x 75cm | PW019 |

PILLOWS

CONTINENTAL PILLOWS

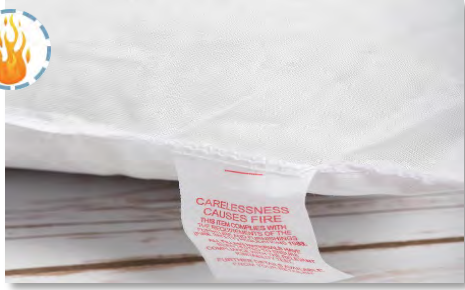

Larger and heavier than standard pillows, ideal for use in nursing homes. Hollowfibre filling and polycotton cover. Pillow weighs 650g.

- Hollowfibre filling
- Made in the UK
- Cover made from easycare polycotton fabric

| Product name | Size | Code |
|---------------------|-------------|-------|
| Continental pillows | 50cm x 76cm | PW001 |

CURLED FEATHER PILLOW



Flatter shaped pillow than other fillings. Filled with curled duck feathers. Pillow weighs 1kg. Made in the UK.

- Polycotton cover
- Curled feather filling
- Available in white

| Product name | Size | Code |
|-----------------------|-------------|-------|
| Curled feather pillow | 50cm x 75cm | PW000 |

V-SHAPED WIPE CLEAN PILLOWS



Lightweight and comfortable, the V-shaped pillow supports the head, neck and shoulders. The "Drishield" cover is wipe clean and flame retardant to BS7175 Source 5.

- Pale green tint colour
- Unique V shape

| Product name | Size | Code |
|-----------------|--------------|-------|
| V shaped pillow | 73cm x 110cm | PW922 |

SCRUBS: 8 COLOURS AVAILABLE IN 8 SIZES



See on pg. 22-23

DUVETS

FIRE RETARDANT WIPE CLEAN DUVET



Fire retardant wipe clean hollowfibre 10.5 tog duvets used in hospitals and nursing homes. Drishield wipeable duvet. Made in the UK.

- Compliant with BS7175 Source 5
- Polypropylene cover
- All seasons 10.5 tog weight

| Product name | Size | Code |
|----------------------------------|---------------|-------------|
| FR wipe clean duvet – single bed | 135cm x 200cm | DV127135200 |
| FR wipe clean duvet – double bed | 200cm x 200cm | DV127200200 |

FIRE RETARDANT WATERPROOF DUVETS



Used by hospitals and nursing homes, these waterproof hollowfibre duvets are lightweight and practical. Made in the UK.

- Ultra high frequency welded seams
- Fire retardant to BS7175 Source 5
- Lightweight 9 tog weight

| Product name | Size | Code |
|-------------------------------|---------------|-------------|
| Waterproof duvet – single bed | 137cm x 198cm | DV501137198 |
| Waterproof duvet – double bed | 190cm x 190cm | DV501198198 |

FIRE RETARDANT HOLLOWFIBRE DUVETS



Fire retardant hollowfibre 10.5 tog single and double duvets used in hospitals and nursing homes. Complies with BS7175 Source 5.

- All seasons 10.5 tog weight
- Made in the UK
- 100% cotton cover

| Product name | Size | Code |
|-----------------------------------|---------------|-------------|
| FR hollowfibre duvet – single bed | 135cm x 200cm | DV100135200 |
| FR hollowfibre duvet – double bed | 200cm x 200cm | DV100198198 |

HOLLOWFIBRE DUVETS



Lightweight, inexpensive hollowfibre duvet. All seasons 10.5 tog weight. Long-lasting, durable and comfortable. Made in the UK.

- Washable at 40 degrees
- Polycotton cover
- Polyester hollowfibre filling

| Product name | Size | Code |
|--------------------------------|---------------|-------------|
| Hollowfibre duvet – single bed | 137cm x 198cm | DV110137198 |
| Hollowfibre duvet – double bed | 198cm x 198cm | DV110198198 |

MATTRESS PROTECTION: DRAW SHEETS

UNBLEACHED DRAW SHEETS



100% unbleached cotton draw sheet, used by hospitals and nursing homes. Place under the sheet for added comfort & mattress protection.

- Unbleached cotton twill
- Durable fabric
- Protect against accidental leaks and spills

| Product name | Size | Code | Supply chain code |
|------------------------------------|---------------|-------------|-------------------|
| Unbleached draw sheet – single bed | 115cm x 185cm | DS000115185 | N1207513 |

COTTON FLANNELETTE DRAW SHEETS



Warm cotton flannelette draw sheets protects the mattress and add comfort for the patient. Used in hospitals and nursing homes.

- 100% cotton white flannelette
- Protect against accidental leaks and spills

| Product name | Size | Code |
|--|---------------|-------------|
| Cotton flannelette draw sheet – single bed | 115cm x 185cm | DS015115185 |

COTTON RICH DRAW SHEETS



Used in hospitals & nursing homes, this draw sheet is used as a base sheet under regular bedding. Cost effective way to protect the mattress and sheets without using plastic.

- Easycare washing and fast drying
- Protect against accidental leaks and spills

| Product name | Size | Code |
|---|---------------|-------------|
| Cotton rich white draw sheet – single bed | 115cm x 178cm | DS075115178 |

You might also like



Flat slide sheets and tubular slide sheets on page 35-46

MATTRESS PROTECTORS

POLYCOTTON QUILTED MATTRESS PROTECTOR



Fully fitted quilted mattress protector for single beds. Used in hospitals, nursing homes & local authority temporary accommodation.

- Waterproof layer inside
- Protect against accidental leaks and spills
- Elasticated edges

| Product name | Size | Code |
|---|---------------|-------------|
| Polycotton quilted protector – single bed | 90cm x 190cm | MP001-90190 |
| Polycotton quilted protector – double bed | 137cm x 190cm | MP001137190 |

WATERPROOF POLYPROPYLENE MATTRESS PROTECTOR



Quilted waterproof mattress protectors to cover single bed mattresses as used in nursing homes and hospitals.

- Polypropylene cover
- Fully fitted with elasticated edges
- Protect against accidental leaks and spills

| Product name | Size | Code |
|---------------------------------------|---------------|-------------|
| Waterproof polypropylene – single bed | 91cm x 190cm | MP015-91190 |
| Waterproof polypropylene – double bed | 137cm x 109cm | MP015137190 |



View heel protectors on page 42

Three reasons to open an online account

With an online Interweave account, you can:

1. Buy online without having to enter your personal details each time;
2. Re-order your favourites very easily, with the Quick re-order form; and
3. Access discounted prices and web-only special offers.

Apply today!

SECLUSION BEDDING

CUSTODY BLANKET



Blanket made from single layer polyester fabric.

- Bedding size: single
- Available in green
- Complies with flame retardant regulation BS5185
- For use in combination with supervision

| Product name | Size | Code |
|-----------------|---------------|-------------|
| Custody blanket | 180cm x 230cm | BS050180230 |

SECLUSION BLANKET



Heavyweight dual-layer blanket made from Secure-TEX fabric, designed for use in prisons and prison cells.

- Bedding size: single
- Available in green
- Complies with flame retardant regulation BS7175 Source 7
- For use in combination with supervision

| Product name | Size | Code |
|-------------------|---------------|-------------|
| Seclusion blanket | 145cm x 180cm | BK850145180 |

SECLUSION MATTRESS COVER



Heavyweight dual-layer blanket made from Secure-TEX fabric with mattress shaping & elasticated edges. Closes with a Velcro strip.

- Bedding size: single
- Covers 19cm deep mattress
- Complies with flame retardant regulation BS5185
- For use in combination with supervision

| Product name | Size | Code |
|--------------------------|--------------|-------------|
| Seclusion mattress cover | 92cm x 183cm | MP050-92193 |

SECLUSION SEALED PILLOW



Sealed pillow with heavyweight Secure-TEX fabric cover.

- Hollowfibre polyester filling
- Available in green
- Complies with flame retardant regulation BS5185
- For use in combination with supervision

50

| Product name | Size | Code |
|-------------------------|-------------|-------------|
| Seclusion sealed pillow | 45cm x 68cm | PW050-45-68 |



Buy all this online today – Free delivery on orders over £50! *



* applies to UK mainland delivery addresses

HOSPITAL TOWELS & WHITE TOWELS

HOSPITAL PROPERTY TOWELS



Highly absorbent white cotton towels with Hospital Property interwoven across the centre of the towel. Suitable for laundering at thermal disinfection temperatures.

- 100% cotton
- Designed for quick drying

| Product name | Size | Code | Supply chain code |
|-------------------------------|--------------|-------------|-------------------|
| Hospital property hand towels | 40cm x 100cm | TW202-48100 | N/A |
| Hospital property bath towels | 65cm x 125cm | TW312-65125 | N1207522 |
| Hospital property bath sheets | 90cm x 150cm | TW802-90150 | N/A |

COTTON TOWELLING WIPE

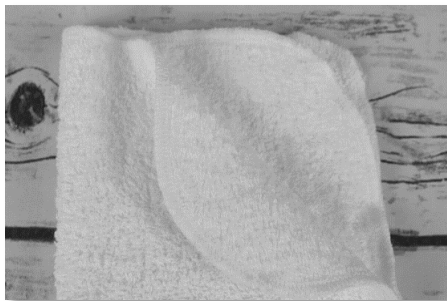

Cotton towelling wipe available in multiples of 10. Overlapped edges for better durability.

- Reusable cotton wipes
- Available in white
- Durable

| Product name | Size | Code |
|-----------------------|-------------|-------------|
| Cotton towelling wipe | 30cm x 30cm | TW070-30-30 |

CONTRACT WHITE TOWELS



Highly absorbent white cotton towels. Used by care homes, hotels and private hospitals. 500gsm cotton fabric.

- Various sizes available
- Soft and durable
- Available in white

| Product name | Size | Code |
|----------------------------|---------------|-------------|
| Contract white face cloths | 30cm x 30cm | TW039-30-30 |
| Contract white hand towels | 50cm x 90cm | TW239-50-90 |
| Contract white bath towels | 70cm x 135cm | TW439-70135 |
| Contract white bath sheets | 100cm x 150cm | TW839100150 |

BATHMATS



100% cotton bathmat for use in care homes, nursing homes, hotels and private hospitals. Washes well at high temperatures.

- Highly absorbent material
- Soft and durable

| Product name | Size | Code |
|-------------------------|-------------|-------------|
| Contract white bathmats | 51cm x 76cm | TW930-51-76 |

PLAIN COLOURED TOWELS

FACE CLOTHS & TOWELS



100% carded cotton towels are suitable for care homes, nursing homes, private hospitals and hospitality. 480gsm weight.

- Durable and soft
- Quick to dry
- Available in 14 colours

| Product name | Size | Code |
|--|--------------|-------|
| Coloured face cloths – various colours | 30cm x 30cm | TW053 |
| Coloured hand towels – various colours | 50cm x 90cm | TW253 |
| Coloured bath towels – various colours | 70cm x 125cm | TW453 |
| Coloured bath sheets – various colours | 90cm x 150cm | TW853 |



MIRAGE BATH MAT



Comfortable 100% cotton bathmat at 750gsm weight. Durable and soft. Used in nursing homes, care homes and private hospitals.

- Available in white & ivory
- Soft and comfortable material

| Product name | Size | Code |
|---------------------------------|-------------|-------------|
| Mirage bathmat – white or ivory | 50cm x 80cm | TW953-50-80 |

BABY HOODED TOWEL



Soft white 100% cotton baby towel with built in hood. 400gsm weight for a lightweight, soft towel that is highly absorbent and dries quickly.

- Suitable for hospital laundries
- Lightweight soft white towel
- Built-in hood

| Product name | Size | Code |
|---------------------------|-------------|-------------|
| Hooded baby towel - white | 68cm x 68cm | TW712-68-68 |

KITCHEN LINEN

KITCHEN TOWEL



100% cotton herringbone white kitchen towel with a green border. Used by nursing homes, care homes and hospitals. Ideal for any catering environment.

- Suitable for laundering at thermal disinfection temperatures

| Product name | Size | Code |
|---------------|-------------|-------------|
| Kitchen towel | 50cm x 75cm | TT600-50-75 |

OVEN CLOTH



Unbleached cotton oven cloth, in herringbone weave. Used by nursing homes, care homes and hospitals. Ideal for any catering environment.

- Suitable for laundering at thermal disinfection temperatures
- 100% cotton

| Product name | Size | Code |
|--------------|-------------|-------------|
| Oven cloth | 50cm x 75cm | TT800-50-76 |

TEA TOWEL



100% cotton tea towel with a blue border. Used by nursing homes, care homes, and hospitals. Ideal for any catering environment.

- Quick drying
- Suitable for laundering at thermal disinfection temperatures

| Product name | Size | Code |
|--------------|-------------|-------------|
| Tea towel | 50cm x 75cm | TT002-50-75 |

Same day dispatch on all stocked kitchen linens to UK mainland addresses. Simply buy online before 1pm*.

*Weekdays only



SCRUB SUITS

SCRUB SUIT TOPS



Unisex V-neck scrubs suit top worn by healthcare professionals, including nurses, doctors, dentistry staff and vets. The polycotton scrubs top is reversible, with a hip pocket on both the inside and outside.

- Available in 8 colours
- Colour coded neck binding for sizing
- Available in 8 sizes: XS-4XL
- Suitable for laundering at thermal disinfection temperatures

Colours available



| Scrub suit top sizing | XS | S | M | L | XL | XXL | XXXL | 4XL |
|--------------------------|-----|-----|-----|-----|-----|-----|------|-----|
| Chest circumference (cm) | 101 | 107 | 119 | 129 | 142 | 147 | 154 | 163 |

| Product name | Size | Code |
|--|--------|-------|
| Scrub suit top – various sizes & colours | XS-4XL | SS017 |

SCRUB SUIT TROUSERS

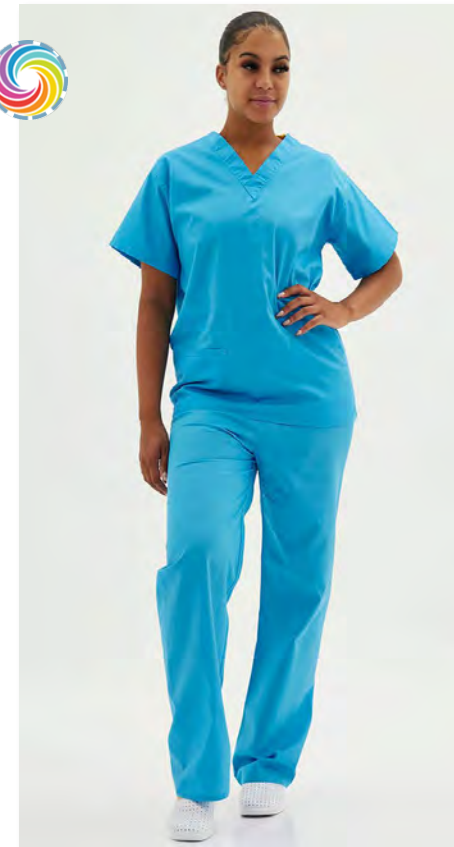

The scrub suit trousers feature a rear square pocket, which is available on both the inside and outside. Draw cord waist. These unisex trousers are worn by healthcare professionals including nurses, doctors, dentistry staff & vets.

- Available in 8 colours
- Colour coded waist cord for sizing
- Available in 8 sizes: XS-4XL
- Suitable for laundering at thermal disinfection temperatures

Colours available

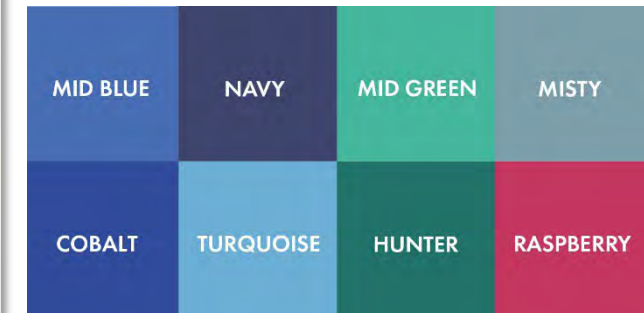

| Scrub suit top sizing | XS | S | M | L | XL | XXL | XXXL | 4XL |
|--------------------------|-----|-----|-----|-----|-----|-----|------|-----|
| Chest circumference (cm) | 101 | 107 | 119 | 129 | 142 | 147 | 154 | 163 |

| Product name | Size | Code |
|---|--------|-------|
| Scrub suit trousers – various sizes & colours | XS-4XL | SS417 |

SCRUB SUITS

WARM UP JACKET



Comfortable polycotton long sleeved jacket designed to wear over scrub suits, Easycare and washes well time after time.

- Available in 2 colours
- Available in 6 sizes: S – XXL
- Elasticated cuffs
- Suitable for laundering at thermal disinfection temperatures

Colours available



Mid blue



Mid green

| Warm up jacket sizing | S | M | L | XL | XXL |
|--------------------------|-----|-----|-----|-----|-----|
| Chest circumference (cm) | 107 | 119 | 129 | 142 | 147 |

| Product name | Size | Code |
|---|---------|-------|
| Warm up jacket – available in 2 colours | S – 3XL | SS817 |

MORTICIAN GOWN



Practical mortician hospital gown. Polycotton fabric available in jade green. One size fits all. Elasticated cuffs to keep sleeves back.

- Available in 1 adult size
- Suitable for laundering at thermal disinfection temperatures



Mortician gown sizing (cm)

| | |
|---------------|-------|
| Circumference | 170cm |
| Length | 116cm |
| Sleeve length | 51cm |

| Product name | Size | Code |
|-----------------------------|----------|-------|
| Mortician gown – jade green | One size | PG600 |

SCRUB SUITS: WONDERWORK TOPS

UNISEX V-NECK SCRUB TOP

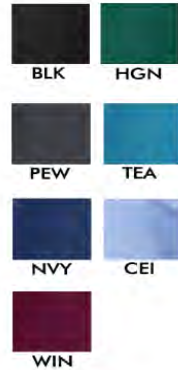

Basic fit scrub top designed to flatter any figure. Motion stretch fabric with double chest pockets.

- Available in 6 colours
- 65% polyester & 35% cotton
- Comfortable fabric

| Product name | Size | Code |
|-------------------------|---------|-------|
| Unisex V neck scrub top | S - XXL | SS100 |

MENS V-NECK SCRUB TOP



V neck scrub top with special motion stretch fabric for whole shift comfort. High thread count fabric.

- Available in 6 colours
- 65% polyester & 35% cotton
- Comfortable fabric

| Product name | Size | Code |
|------------------------|---------|-------|
| Men's V neck scrub top | S - XXL | SS103 |

WOMENS V-NECK SCRUB TOP

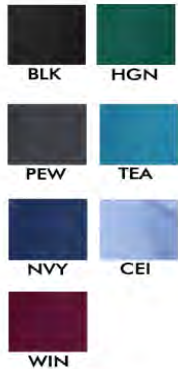

Comfortable V neck design made with motion stretch fabric. Flattering fit with two deep front pockets.

- Available in 6 colours
- 65% polyester & 35% cotton
- Machine washable up to 60 degrees

| Product name | Size | Code |
|-------------------------|---------|-------|
| Unisex V neck scrub top | S - XXL | SS101 |

Unisex Size Guide

| Sizes (cm) | XXS | XS | S | M | L | XL | 2XL | 3XL | 4XL | 5XL |
|--------------|-----|----|----|----|-----|-----|-----|-----|-----|-----|
| Chest | 78 | 83 | 89 | 97 | 104 | 114 | 124 | 134 | 145 | 155 |
| Waist | 58 | 63 | 68 | 76 | 83 | 94 | 104 | 114 | 124 | 134 |

Women's Size Guide

| Sizes (cm) | XXS | XS | S | M | L | XL | 2XL | 3XL | 4XL | 5XL |
|--------------|-----|----|----|----|----|-----|-----|-----|-----|-----|
| Chest | 76 | 81 | 86 | 91 | 99 | 109 | 119 | 129 | 139 | 149 |
| Waist | 55 | 60 | 66 | 71 | 78 | 88 | 99 | 109 | 119 | 129 |

Men's Size Guide

| Sizes (cm) | XXS | XS | S | M | L | XL | 2XL | 3XL | 4XL | 5XL |
|--------------|-----|----|----|----|-----|-----|-----|-----|-----|-----|
| Chest | 78 | 83 | 89 | 97 | 104 | 114 | 124 | 134 | 145 | 155 |
| Waist | 58 | 63 | 68 | 76 | 83 | 94 | 104 | 114 | 124 | 134 |

SCRUB SUITS: WONDERWORK TROUSERS

UNISEX CARGO SCRUBS TROUSERS

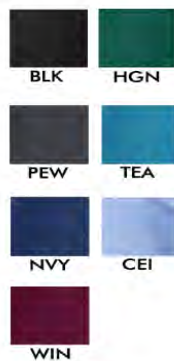

Classic cargo scrub design with back pocket & leg multi pocket. Stylish and flattering with a special stretch fabric.

- Available in 7 colours
- 65% polyester & 35% cotton
- Drawstring waist

| Product name | Size | Code |
|-----------------------------|---------|-------|
| Unisex cargo scrub trousers | S - XXL | SS500 |

MENS CARGO SCRUB TROUSERS



Comfortable scrub trousers with motion stretch fabric. Part elasticated & drawstring waist.

- Available in 6 colours
- 65% polyester & 35% cotton
- Features 5 pockets

| Product name | Size | Code |
|----------------------------|---------|-------|
| Men's cargo scrub trousers | S - XXL | SS530 |

WOMENS PULL-ON CARGO SCRUB TROUSERS

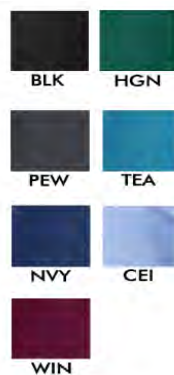

Slimline scrub trousers with a motion stretch fabric for comfort. Elasticated waist with multiple pockets.

- Available in 6 colours
- 65% polyester & 35% cotton
- Higher waistband for extra coverage

| Product name | Size | Code |
|--------------------------------------|--------|-------|
| Women's pull-on cargo scrub trousers | S - XL | SS534 |

Unisex Size Guide

| Sizes (cm) | XXS | XS | S | M | L | XL | 2XL | 3XL | 4XL | 5XL |
|------------|-----|----|----|----|-----|-----|-----|-----|-----|-----|
| Hips | 81 | 86 | 91 | 99 | 106 | 116 | 127 | 137 | 147 | 157 |

In-seam length: Regular: 78cm, Short: 71cm, Long: 83cm

Women's Size Guide

| Sizes (cm) | XXS | XS | S | M | L | XL | 2XL | 3XL | 4XL | 5XL |
|------------|-----|----|----|----|-----|-----|-----|-----|-----|-----|
| Hips | 83 | 88 | 91 | 96 | 104 | 114 | 124 | 134 | 149 | 160 |

In-seam length: Regular: 78cm, Short: 71cm, Long: 83cm

Men's Size Guide

| Sizes (cm) | XXS | XS | S | M | L | XL | 2XL | 3XL | 4XL | 5XL |
|------------|-----|----|----|----|-----|-----|-----|-----|-----|-----|
| Hips | 83 | 88 | 91 | 96 | 104 | 114 | 124 | 134 | 149 | 160 |

In-seam length: Regular: 78cm, Short: 71cm, Long: 83cm

SCRUB ACCESSORIES

SCRUB CAPS



Comfortable scrubs caps that can be matched with scrubs. Keeps hair neat and tidy all shift. Tie tapes & elasticated back.

- One size fits all
- Machine washable up to 60 degrees
- Absorbent towelling strip inside cap
- 65% polyester & 35% cotton

| Product name | Size | Code |
|----------------------|----------|-------|
| Scrub caps - various | One size | SS701 |



Navy



Cobalt



Mid blue



Raspberry



Mid green



Misty

WONDERWINK SCRUB CAPS



Comfortable and stylish scrub caps can be matched with WW scrubs. Keeps hair neat and tidy all shift.

- One size fits all
- Terry cloth sweatband sewn inside
- Available in navy blue
- Tie back closure – covered elastic band

| Product name | Size | Code |
|-----------------------|----------|----------|
| WonderWink scrub caps | One size | SS7000NE |

SIZE BINDING TAPE FOR SCRUB SUITS



Binding taped used to indicate garment sizes for scrubs. Colour coded per size for easy and fast identification.

- Available in 8 colours for sizes
- Used in NHS scrubs
- Sold in rolls of 100 metres

| Product name | Size | Code |
|-------------------|--------|-------|
| Size binding tape | XS-4XL | TA001 |

PATIENT GOWNS

LAPOVER HOSPITAL GOWN



Best selling hospital gown. Comfortable to wear, washes at high temperatures. Polycotton fabric with diamond pattern.

- Fastens with colour-coed ties
- Wrapover at the back with dignity tie
- Suitable for laundering at thermal disinfection temperatures

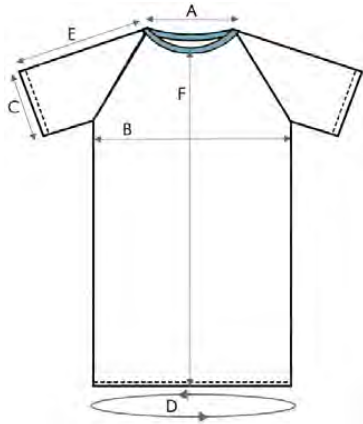

| | | | |
|------------------------------|-------|--|-------|
| A Neck circumference | 65cm | D Sweep around bottom | 155cm |
| B Chest circumference | 146cm | E Arm length | 45cm |
| C Cuff circumference | 48cm | F Length from shoulder high point | 120cm |

| Product name | Size | Code |
|-----------------------|----------|-------|
| Lapover hospital gown | One size | PG044 |

DIGNITY HOSPITAL GOWN



Classed as “outstanding” in an independent report. Reversible front and back patient gown in striped blue and white polycotton easy care fabric.

- Ties at the front or back
- Fastens with colour-coded ties
- Suitable for laundering at thermal disinfection temperatures

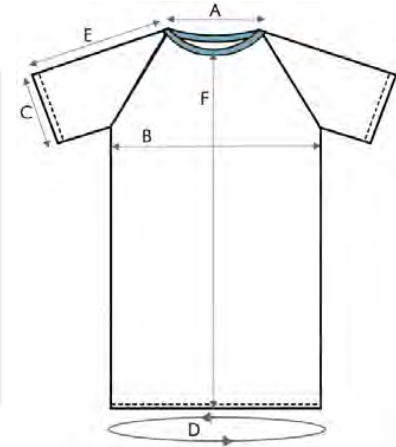

| | | | |
|------------------------------|-------|--|-------|
| A Neck circumference | 90cm | D Sweep around bottom | 172cm |
| B Chest circumference | 140cm | E Arm length | 30cm |
| C Cuff circumference | 58cm | F Length from shoulder high point | 123cm |

| Product name | Size | Code |
|-----------------------|----------|-------|
| Dignity hospital gown | One size | PG825 |

PATIENT GOWNS

POPPER HOSPITAL GOWN



Round necked patient gown in easycare fabric has popper fasteners on the shoulders & at the back. Ideal for any medical procedure.

- No ties – popper fasteners on both shoulders and back
- MRI-friendly plastic popper tape
- Suitable for laundering at thermal disinfection temperatures

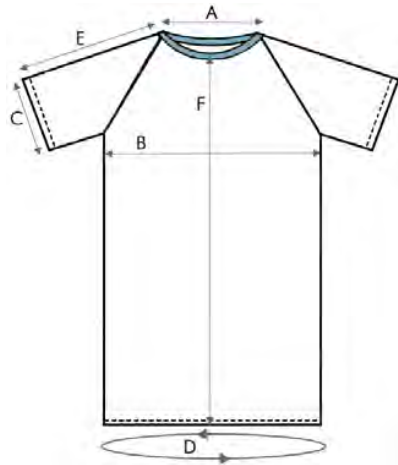
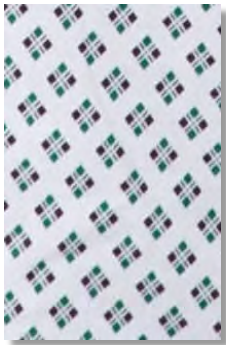

| | | | |
|------------------------------|-------|--|-------|
| A Neck circumference | 49cm | D Sweep around bottom | 144cm |
| B Chest circumference | 142cm | E Arm length | 0cm |
| C Arm hole opening | 47cm | F Length from shoulder high point | 112cm |

| Product name | Size | Code |
|----------------------|------------|-------|
| Popper hospital gown | Adult size | PG038 |

THREE ARM TOGA HOSPITAL GOWN



Three-armed toga hospital patient gown is easy to put on, no ties or poppers to struggle with.

- Unique design provides improved patient dignity
- Blue diamond polycotton fabric print
- Suitable for laundering at thermal disinfection temperatures

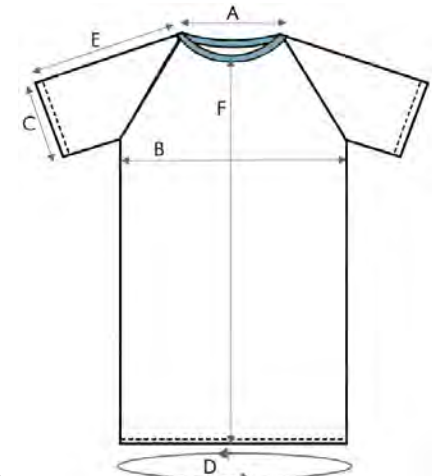
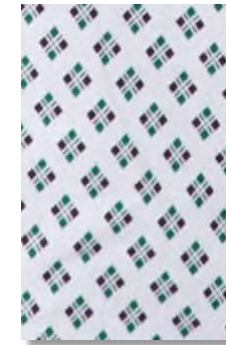

| | | | |
|------------------------------|-------|--|-------|
| A Neck circumference | 89cm | D Sweep around bottom | 250cm |
| B Chest circumference | 164cm | E Arm length | 43cm |
| C Cuff circumference | 45cm | F Length from shoulder high point | 127cm |

| Product name | Size | Code |
|------------------------------|------------|-------|
| Three arm toga hospital gown | Adult size | PG040 |

PATIENT GOWNS

OPERATION HOSPITAL GOWN



Simple white unisex polycotton operation gown designed to be easy to wear. Providing excellent access to the rear.

- Three ties that fasten at the back
- MRI friendly
- Suitable for laundering at thermal disinfection temperatures

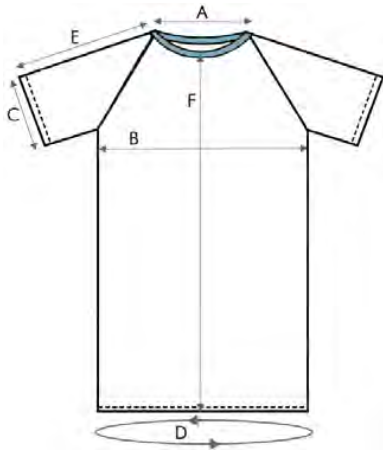

| | | | |
|------------------------------|-------|--|-------|
| A Neck circumference | 74cm | D Sweep around bottom | 155cm |
| B Chest circumference | 140cm | E Arm length | 33cm |
| C Cuff circumference | 50cm | F Length from shoulder high point | 127cm |

| Product name | Size | Code |
|-------------------------|------------|-------|
| Operation hospital gown | Adult size | PG000 |

PULLOVER HOSPITAL GOWN



Easy to put on over the head, no ties or poppers to fasten. Comfortable polycotton hospital gown.

- MRI friendly
- Long opening at the back
- Suitable for laundering at thermal disinfection temperatures

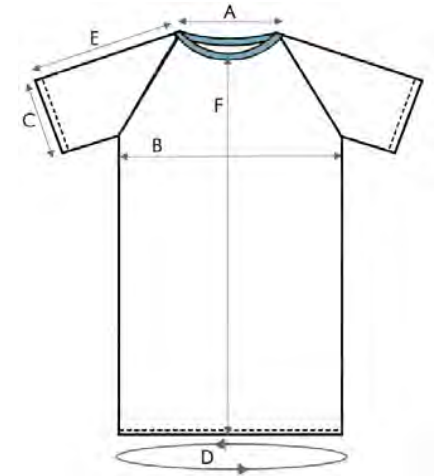
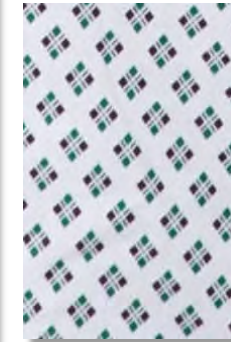

| | | | |
|------------------------------|-------|--|-------|
| A Neck circumference | 65cm | D Sweep around bottom | 160cm |
| B Chest circumference | 148cm | E Arm length | 43cm |
| C Cuff circumference | 48cm | F Length from shoulder high point | 128cm |

| Product name | Size | Code |
|------------------------|------------|-------|
| Pullover hospital gown | Adult size | PG033 |

PATIENT GOWNS

BARIATRIC 4XL HOSPITAL GOWN



Plus size bariatric patient gown is easy to put on and comfortable to wear. Made from easycare polycotton.

- Fastens with colour-coded ties
- Wrapover at the back with dignity tie
- Suitable for laundering at thermal disinfection temperatures

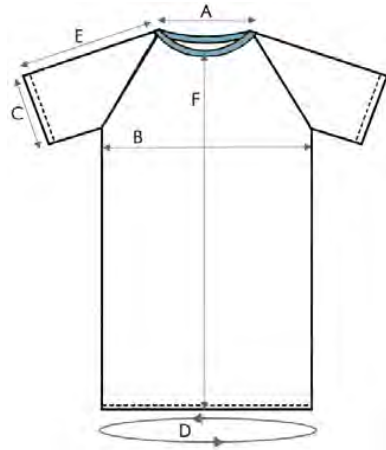
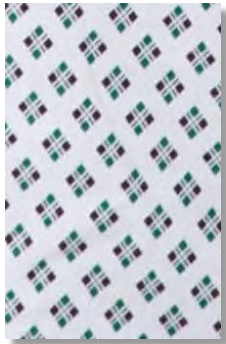

| | | | |
|------------------------------|-------|--|-------|
| A Neck circumference | 92cm | D Sweep around bottom | 180cm |
| B Chest circumference | 164cm | E Arm length | 47cm |
| C Cuff circumference | 56cm | F Length from shoulder high point | 122cm |

| Product name | Size | Code |
|-----------------------------|----------|----------|
| Bariatric 4XL hospital gown | One size | PG0444XL |

BARIATRIC 10XL HOSPITAL GOWN



10XL bariatric patient gown is easy to put on and very comfortable to wear. Made from easycare polycotton.

- MRI friendly
- Opening at the back, with ties at the neck & waist, with wrapover
- Suitable for laundering at thermal disinfection temperatures

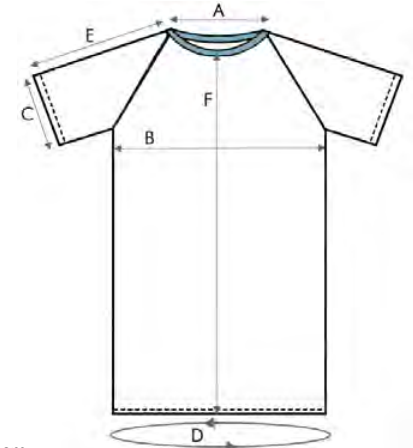

| | | | |
|------------------------------|-------|--|-------|
| A Neck circumference | 106cm | D Sweep around bottom | 263cm |
| B Chest circumference | 244cm | E Arm length | 44cm |
| C Cuff circumference | 84cm | F Length from shoulder high point | 120cm |

| Product name | Size | Code |
|------------------------------|----------|----------|
| Bariatric 10XL hospital gown | One size | PG00410L |

DRESSING GOWNS

DRESSING GOWN



Polycotton unisex dressing gown fits all sizes.
Mid length gown with waist tie.

- Unisex patient robe
- Lightweight polycotton fabric
- Suitable for laundering at thermal disinfection temperatures

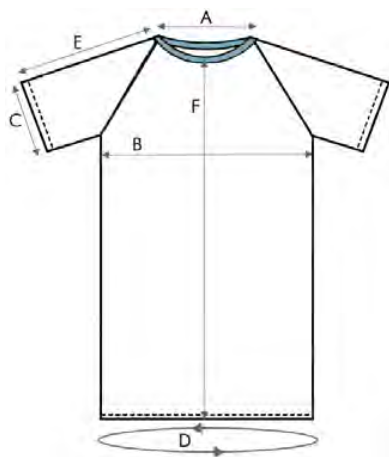

| | | | |
|------------------------------|-------|--|-------|
| A Neck circumference | N/A | D Sweep around bottom | 142cm |
| B Chest circumference | 140cm | E Arm length | 34cm |
| C Cuff circumference | 45cm | F Length from shoulder high point | 117cm |

| Product name | Size | Code |
|-----------------------------|----------|-------|
| Dressing gown – blue stripe | One size | PG815 |

HOSPITAL USE ONLY DRESSING GOWN



Lightweight polycotton unisex dressing gown.
Fits all sizes. Long length gown with waist tie.

- Unisex patient robe
- Available in “hospital use only” autumn print
- Suitable for laundering at thermal disinfection temperatures

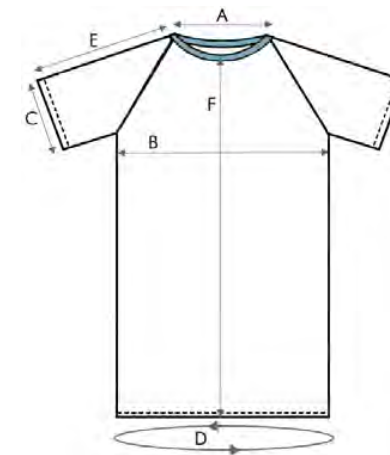

| | | | |
|------------------------------|-------|--|-------|
| A Neck circumference | N/A | D Sweep around bottom | 156cm |
| B Chest circumference | 150cm | E Arm length | 34cm |
| C Cuff circumference | 45cm | F Length from shoulder high point | 121cm |

| Product name | Size | Code |
|---|----------|-------|
| Dressing gown – “hospital use only” print | One size | PG817 |

MAMMOGRAM GOWNS

MAMMOGRAPHY CAPE



Hospital gown for mammography procedures.
Easy to put on, poppers down the front.

- Lightweight polycotton fabric
- Available in blue and white stripes
- Suitable for laundering at thermal disinfection temperatures



| | | | |
|------------------------------|-------|--|------|
| A Neck circumference | 54cm | C Arm length | 58cm |
| B Sweep around bottom | 450cm | D Length from shoulder high point | 83cm |

| Product name | Size | Code |
|------------------|----------|-------|
| Mammography cape | One size | PG047 |



LAUNDRER HOT
For thermal disinfection, after every use



FOUR WAY STRETCH
Only takes one person to make a bed



EASYCARE
No creases, minimises pressure sores



FULL BEDDING RANGE
Maximum patient comfort

Browse the Interfit bedding range on page 5

INTERFAITH PATIENT GOWNS

HEAD SCARF



Head scarf to be worn in hospital to provide patient dignity and fully cover the head and hair.

Wear with the Interfaith patient gown and other accessories.

| Product name | Size | Code |
|-----------------------|-------------|----------|
| Interfaith head scarf | 82cm x 82cm | PG602-82 |

HEAD COVER



Worn by female patients to maintain dignity when in hospital.

Wear with the Interfaith gown and trousers for the full outfit.

| Product name | Size | Code |
|-----------------------|-------------|-------------|
| Interfaith head cover | 70cm x 52cm | PG603-52-70 |

FACE COVER



Female patients face cover for modesty when in hospital.

| Product name | Size | Code |
|-----------------------|-------------|-------------|
| Interfaith face cover | 36cm X 31cm | PG604-36-31 |

GOWN



Short patient gown to be worn with matching polycotton trousers and other accessories.

Provides dignity and full cover-up for female patients who wish to remain covered up.

| Product name | Size | Code |
|-----------------|----------|-------|
| Interfaith gown | One size | PG600 |

TROUSERS

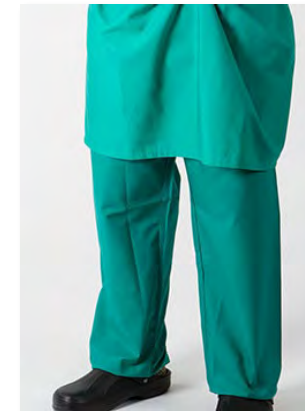

Hospital gown trousers to be worn with the Interfaith hospital gown and accessories.

Suitable for female patients who wish to remain covered up.

| Product name | Size | Code |
|---------------------|----------|-------|
| Interfaith trousers | One size | PG601 |

CHILDRENS HOSPITAL GOWN

BABY HOSPITAL GOWN



Hospital operation gown for babies, made with soft white flannelette. The gown back opening fastens with cotton ties.

- Baby operation gown
- Suitable for laundering at thermal disinfection temperatures

| Product name | Size | Code |
|----------------------------|----------|-------|
| Baby hospital gown - white | One size | PG405 |

CHILDREN'S HOSPITAL GOWN



Polycotton hospital operation gown for children in fun print design. Easy fasten with cotton ties at the back. Seaside print.

- Suitable for laundering at thermal disinfection temperatures
- Colour coded tie tapes for sizing

| Product name | Size | Code |
|-------------------------------|--------|-------|
| Child hospital gown - printed | S - XL | PG400 |

BABY PRINTED HOSPITAL GOWN



Operation gown for babies, made from soft patterned cotton flannelette. Tie at the back with cotton ties.

- Suitable for laundering at thermal disinfection temperatures
- Available in nursery rhyme pattern

| Product name | Size | Code |
|------------------------------|----------|-------|
| Baby hospital gown - printed | One size | PG401 |

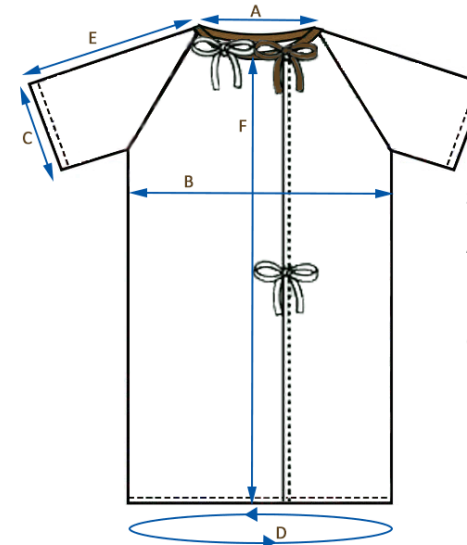

Children's hospital gown

| Sizes (cm) | S | M | L | XL |
|-----------------------|----|-----|-----|-----|
| A Neck circumference | 32 | 36 | 40 | 50 |
| B Chest circumference | 74 | 86 | 108 | 116 |
| C Cuff circumference | 30 | 33 | 37 | 42 |
| D Sweep around bottom | 82 | 100 | 116 | 129 |
| E Arm length | 26 | 30 | 34 | 37 |
| F Gown length | 38 | 53 | 67 | 82 |

NIGHTWEAR

OPEN BACKED NIGHTDRESS



Open-backed polycotton hospital nightdress is designed to be worn loose and comfortable. The cross-over neck has increased dignity.

At the back, the lower half has a wrap-over split for easy access.

- Colour coded neck binding for sizing
- Suitable for laundering at thermal disinfection temperatures

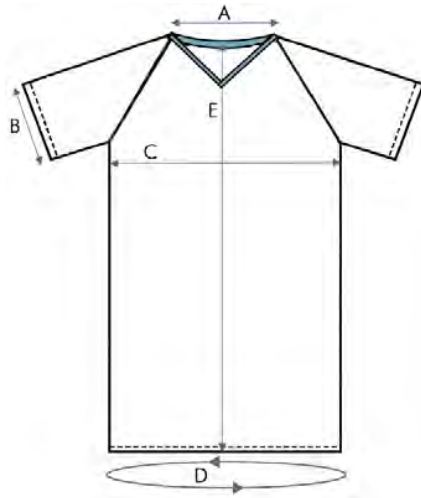

| Sizes (cm) | Adult | 4XL |
|------------------------|-------|-----|
| A Neck circumference | 62 | 62 |
| B Sleeve circumference | 46 | 56 |
| C Chest circumference | 128 | 146 |
| D Sweep around bottom | 148 | 177 |
| E Length | 110 | 115 |

| Product name | Size | Code |
|------------------------|-------------|-------|
| Open backed nightdress | Adult & 4XL | NW405 |

CLOSED BACK NIGHTDRESS



This hospital nightdress has a closed back design, short sleeves and a cross-over top for increased dignity.

Easycare polycotton. Available in "hospital use only" print.

- Colour coded neck binding for sizing
- Suitable for laundering at thermal disinfection temperatures

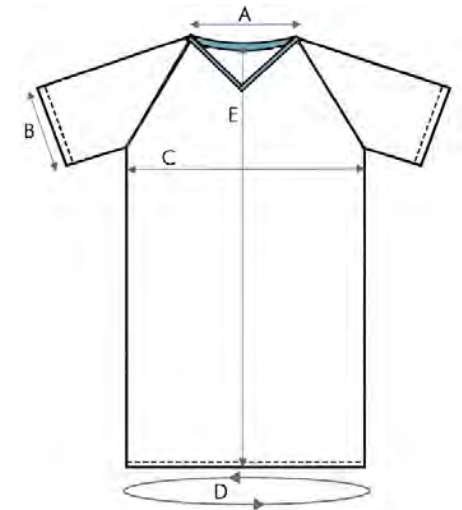
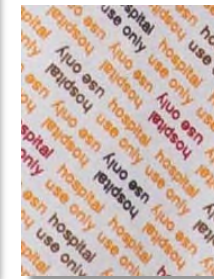

| Sizes (cm) | Adult | 4XL |
|------------------------|-------|-----|
| A Neck circumference | 62 | 62 |
| B Sleeve circumference | 46 | 56 |
| C Chest circumference | 128 | 146 |
| D Sweep around bottom | 148 | 177 |
| E Length | 110 | 115 |

| Product name | Size | Code |
|------------------------|-------------|-------|
| Closed back nightdress | Adult & 4XL | NW605 |

NIGHTWEAR

PYJAMA JACKET & TROUSERS



Lightweight unisex polycotton hospital pyjama jacket and separate trousers in “Hospital use only” print. Four clear plastic buttons.

- Trousers have elasticated waist with button & fly
- Suitable for laundering at thermal disinfection temperatures

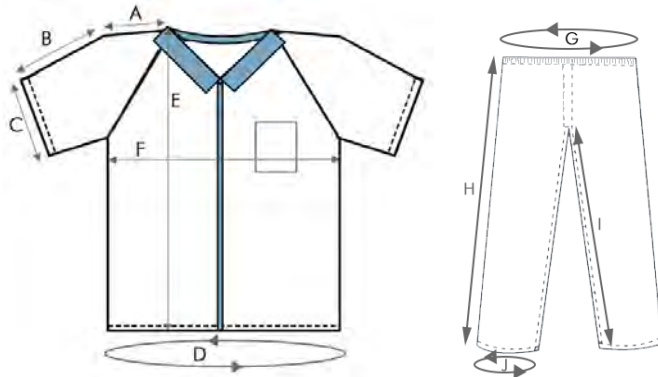

| TOP: Sizes (cm) | XL | 4XL |
|-----------------------|-----|-----|
| A Shoulder | 22 | 25 |
| B Arm length | 58 | 62 |
| C Cuff circumference | 38 | 40 |
| D Sweep around bottom | 142 | 156 |
| E Length | 76 | 82 |
| F Chest circumference | 142 | 156 |

| TROUSERS: Sizes (cm) | XL | 4XL |
|----------------------|-----|-----|
| G Waist (relaxed) | 66 | 84 |
| G Waist (stretched) | 142 | 156 |
| H Outside leg | 106 | 114 |
| I Inside leg | 71 | 74 |
| J Cuff circumference | 50 | 57 |

| Product name | Size | Code |
|-----------------|---------|-------|
| Pyjama jacket | XL, 4XL | NW005 |
| Pyjama trousers | XL, 4XL | NW202 |

NIGHTSHIRT



Polycotton hospital nightshirt in “Hospital use only” forest print. At the back, the lower half has a wrap-over split for convenience and easy access,

- 4 clear plastic buttons
- Open back
- Suitable for laundering at thermal disinfection temperatures

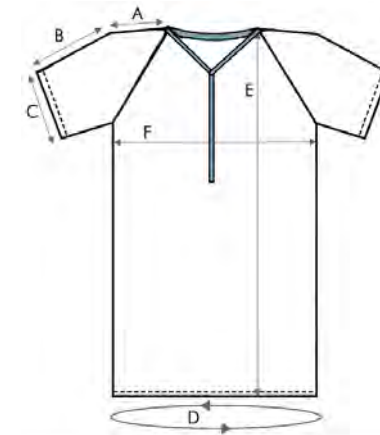

| Sizes (cm) | XL |
|-----------------------|-----|
| A Shoulder | 17 |
| B Arm length | 27 |
| C Cuff circumference | 44 |
| D Sweep around bottom | 132 |
| E Length | 106 |
| F Chest circumference | 119 |

| Product name | Size | Code |
|---------------------|------|-------|
| Hospital nightshirt | XL | NW897 |

SLIPPER SOCKS

SINGLE TREAD



Reduce the risk of falling accidents with latex free slipper socks for patients and nursing home residents. Stretchy sock fits comfortably.

- Latex free unisex socks
- Tread on the sole of the foot
- Not suitable for laundering

| Product name | Size | Code | Supply chain code |
|----------------------------|--------|-------|-------------------|
| Single tread slipper socks | XS-XXL | SK000 | Various |

FALL PREVENTION



Fall prevention slipper socks in bright yellow and bright red for patients who are at a high risk of falling. Helps identify these patients easily.

- Not suitable for laundering
- Tread on both sides of the foot

| Product name | Size | Code | Supply chain code |
|---------------------------|---------|-----------|-------------------|
| S - XXL | S - XL | SK002-YEL | Various |
| Fall prevention socks red | XL only | SK002-RED | Various |

DOUBLE TREAD



Latex free slipper socks patients with tread under the sole and on top of the foot. Reduces falls risk. Easy to put on and reduces risk of incorrect use,

- Not suitable for laundering
- Tread on both sides of the foot

| Product name | Size | Code | Supply chain code |
|----------------------------|---------|-------|-------------------|
| Double tread slipper socks | S - 3XL | SK001 | Various |



| Sizes (cm) | XS | S | M | L | XL | XXL | 3XL |
|--------------|--------|-----|-------|------|-------|-------|---------|
| UK Shoe size | 1-2 | 3-4 | 4-5 | 5-8 | 8-11 | 11-13 | 13+ |
| Colour | Yellow | Red | Green | Blue | Beige | Grey | Dk grey |

Please note: We recommend always buying one size larger than your regular shoe size.

Same day dispatch on all slipper socks to UK mainland addresses. Simply buy online before 1pm*.

*Weekdays only



COMPRESSION SOCKS

HEALTHYLEGS ELITE COMPRESSION SOCKS



To be worn after discharge from hospital or after prolonged periods of reduced mobility. The socks apply graduated compression up the legs to improve circulation.

- Below knee socks
- Comfortable heel patch
- Machine washable
- Inspection hole

| Product name | Size | Code |
|-------------------------------------|--------|-------|
| Elite HealthyLegs compression socks | S - XL | SK802 |

HEALTHYLEGS COMPRESSION SOCKS



Clinically effective at reducing the risk of DVT. The socks apply graduated compression up the legs to improve circulation over time. Can support varicose veins, and ease aches and pain in legs.

- Closed toe with inspection hole
- Machine washable
- Below knee socks
- Comfortable heel patch

| Product name | Size | Code |
|-------------------------------|--------|-------|
| HealthyLegs compression socks | S - XL | SK801 |



| Size Guide: | Ankle circumference (cm) | Ankle circumference (inches) |
|---|--------------------------|------------------------------|
| Please check measurements before ordering | | |
| Small | 18-22 cm | 7-9 in |
| Medium | 23-25 cm | 9-10 in |
| Large | 26-28 cm | 10-11 in |
| Extra Large | 29-32 cm | 11.5-13 in |

BABY WRAPS

PATTERNED FLANNELETTE BABY WRAPS



Premium soft cotton, highly absorbent and quick drying baby wraps for hospital use. Available in 2 prints.

- 100% premium cotton flannelette
- 2 print designs available
- Suitable for laundering at thermal disinfection temperatures

Patterns available



Hospital Use Only



Nursery

| Product name | Size | Code |
|-----------------------|------------------------|-------|
| Flannelette baby wrap | One size: 75cm x 100cm | ST815 |

COTTON FLANNELETTE BABY WRAPS



Premium soft cotton, highly absorbent and quick drying baby wraps for hospital use. 100% premium cotton flannelette material.

- Suitable for laundering at thermal disinfection temperatures
- Size: 86cm x 112cm
- Available in white only

| Product name | Size | Code |
|------------------------------|------------------------|-------|
| Cotton flannelette baby wrap | One size: 86cm x 112cm | ST803 |

You might also like



Baby blankets on pg. 10



Baby hooded towels on pg. 20

Same day dispatch on all stocked baby wraps to UK mainland addresses. Simply buy online before 1pm*.

*Weekdays only



SECLUSION WEAR

SECLUSION GOWN



Used in mental health facilities, custody centres and high risk security units, these gowns are made from Secure-Tex fabric. Designed to assist with the prevention of self-harm.

- Fabric is flame retardant, dual-layered and channel stitched.
- Suitable for laundering at thermal disinfection temperatures
- For use in combination with supervision

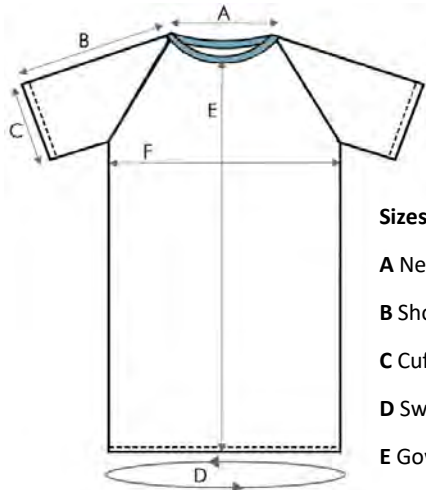

| Sizes (cm) | XS | S | M | L | XL | XXL | 3XL |
|-------------------------|-----|-----|-----|-----|-----|-----|-----|
| A Neck circumference | 49 | 49 | 60 | 65 | 72 | 74 | 76 |
| B Shoulder & arm length | 26 | 28 | 32 | 36 | 40 | 45 | 50 |
| C Cuff circumference | 51 | 51 | 56 | 56 | 56 | 56 | 56 |
| D Sweep | 122 | 131 | 154 | 176 | 191 | 200 | 209 |
| E Gown length | 108 | 109 | 109 | 115 | 115 | 117 | 120 |
| F Chest circumference | 104 | 112 | 129 | 150 | 166 | 184 | 194 |

| Product name | Size | Code |
|----------------|----------|-------|
| Seclusion gown | XS – 3XL | PG950 |

SECLUSION TROUSERS

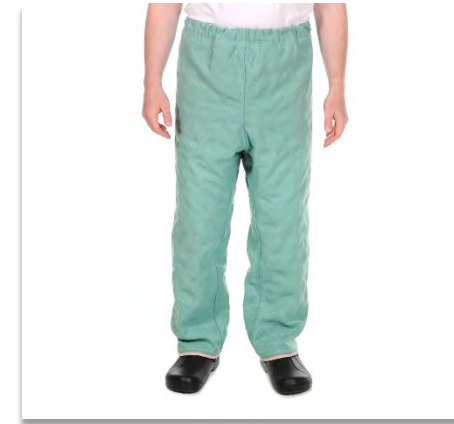

These trousers are made from Secure-Tex fabric and worn with either a tunic or gown in mental health facilities, custody centres and high risk security units. 6-part elasticated waistband. Designed to assist with the prevention of self-harm.

- Fabric is flame retardant, dual-layered and channel stitched.
- Suitable for laundering at thermal disinfection temperatures
- For use in combination with supervision

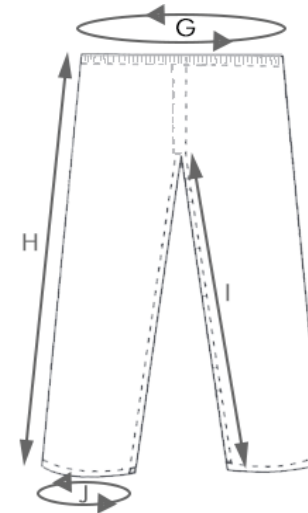

| Sizes (cm) | XS | S | M | L | XL | XXL | 3XL |
|------------------------------|-----|-----|-----|-----|-----|-----|-----|
| G Waist circumference | 91 | 101 | 109 | 121 | 137 | 147 | 157 |
| H Length | 105 | 118 | 118 | 123 | 132 | 132 | 132 |
| I Hips | 94 | 102 | 110 | 120 | 132 | 142 | 152 |
| J Trouser cuff circumference | 38 | 43 | 48 | 53 | 58 | 63 | 68 |

| Product name | Size | Code |
|--------------------|----------|-------|
| Seclusion trousers | XS – 3XL | PG952 |

SECLUSION WEAR

SECLUSION TUNIC



Secure-Tex tunics to be worn with seclusion trousers or shorts for use in mental health facilities, custody centres and high risk security units.

- Fabric is flame retardant, dual-layered and DNA quilt stitched
- Suitable for laundering at thermal disinfection temperatures
- For use in combination with supervision

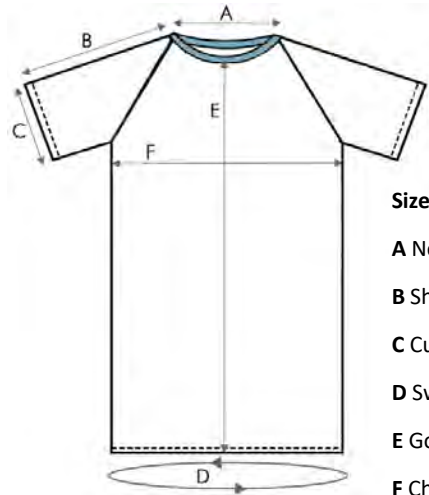

| Sizes (cm) | XS | S | M | L | XL | XXL | 3XL |
|--------------------------------|-----|-----|-----|-----|-----|-----|-----|
| A Neck circumference | 49 | 49 | 60 | 65 | 71 | 74 | 76 |
| B Shoulder & arm length | 24 | 28 | 32 | 36 | 40 | 45 | 50 |
| C Cuff circumference | 51 | 51 | 56 | 56 | 56 | 56 | 56 |
| D Sweep | 122 | 131 | 154 | 176 | 191 | 200 | 209 |
| E Gown length | 80 | 80 | 85 | 86 | 86 | 88 | 91 |
| F Chest circumference | 104 | 112 | 129 | 150 | 166 | 184 | 194 |

| Product name | Size | Code |
|-----------------|----------|-------|
| Seclusion tunic | XS – 3XL | PG951 |

SECLUSION SHORTS



Heavyweight shorts made from Secure-Tex fabric, with reinforced stitching to avoid ripping. 6-part elasticated waistband. To be worn with seclusion tunic for use in mental health facilities, custody centres and high risk security units.

- Fabric is flame retardant, dual-layered and DNA quilt stitched.
- Suitable for laundering at thermal disinfection temperatures
- For use in combination with supervision

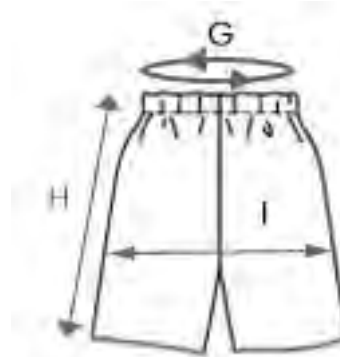

| Sizes (cm) | XS | S | M | L | XL | XXL | 3XL |
|------------------------------|----|-----|-----|-----|-----|-----|-----|
| G Waist circumference | 91 | 101 | 109 | 121 | 137 | 147 | 157 |
| H Length | 59 | 62 | 68 | 73 | 78 | 82 | 94 |
| I Hips | 94 | 102 | 110 | 120 | 132 | 142 | 152 |

| Product name | Size | Code |
|------------------|----------|-------|
| Seclusion shorts | XS – 3XL | PG953 |

PATIENT COMFORT

SHEEPSKIN HEEL PROTECTORS



Pure wool sheepskin heel protectors with soft adjustable Velcro straps. The pure wool fleece with small openings at each side and back of the foot ensures comfort & breathability.

- Machine washable up to 40 degrees
- For use in bed or when sitting
- Suitable for all ankle sizes

| Product name | Size | Code |
|---------------------------|----------|-------|
| Sheepskin heel protectors | One size | PR001 |

BED WEDGE PILLOW



This pillow raises the user slightly in bed, helping sufferers of acid reflux, hiatal hernia and GERD. It can also help snorers by opening airways. Featuring a foam inner and flame retardant cover.

- Washable cotton cover which zips off
- Foam wedge pillow
- Size: 61cm x 61cm

| Product name | Size | Code |
|------------------|----------|-------|
| Bed wedge pillow | One size | PR010 |

FOAM HEEL PROTECTORS



Medical heel pads designed to provide a high level of comfort for patients. Soft foam protects the ankles and heels. Reduces pressure and prevents pressure ulcers.

- Machine washable at 60 degrees
- Air permeable for breathability
- Fire retardant outer and filling

| Product name | Size | Code |
|-------------------------------|----------|-------|
| Foam filled medical heel pads | One size | PR000 |

Same day dispatch on all stocked products to UK mainland addresses. Simply buy online before 1pm*.

*Weekdays only



SLIDE SHEETS – PATIENT SPECIFIC

ELITE PATIENT SPECIFIC FLAT SLIDE SHEETS



Slide sheets allow easy ultra low friction patient movement whilst reducing risk of injury to both carers and patients.

- 100cm x 200cm
- 140cm x 200cm
- 71cm x 200cm
- 90cm x 90cm
- 90cm x 135cm

| Product name | Size | Code | Supply chain code |
|------------------------------------|---------------|-----------------------|-------------------|
| Elite patient specific slide sheet | 100cm x 200cm | PH020100200---REDA62 | TLC686 |
| Elite patient specific slide sheet | 140cm x 200cm | PH020140200---REDA62 | N/A |
| Elite patient specific slide sheet | 71cm x 200cm | PH020-71-200---REDA62 | N/A |
| Elite patient specific slide sheet | 90cm x 90cm | PH020-90-90---REDA62 | FES10778 |
| Elite patient specific slide sheet | 90cm x 135cm | PH020-90135---REDA62 | FES10759 |

ELITE PATIENT SPECIFIC SLIDE SHEET WITH HANDLES



Slide sheets allow easy ultra low friction patient movement whilst reducing risk of injury to both carers and patients. With handles.

- 90cm x 200cm
- 148cm x 220cm
- 140cm x 200cm
- 71cm x 200cm

| Product name | Size | Code | Supply chain code |
|---|---------------|----------------------|-------------------|
| Elite patient specific slide sheet w/ handles | 90cm x 200cm | PH023-90200---REDA62 | VTS094 |
| Elite patient specific slide sheet w/ handles | 148cm x 220cm | PH023148220---REDA62 | TLC688 |
| Elite patient specific slide sheet w/ handles | 140cm x 200cm | PH023140200---REDA62 | N/A |
| Elite patient specific slide sheet w/ handles | 71cm x 200cm | PH023-71200---REDA62 | N/A |

Have you seen the slide sheet bag?

Keep your slide sheets safe and close to the patient with a handy slide sheet bag.

View on pg. 46



Same day dispatch on all stocked products to UK mainland addresses. Simply buy online before 1pm*.

*Weekdays only



SLIDE SHEETS – PATIENT SPECIFIC

PATIENT SPECIFIC TUBULAR SLIDE SHEETS



Slide sheets allow easy low friction patient movement whilst reducing risk of injury to both carers and their patients. Reduce back injury risk.

- 71cm x 145cm
- 71cm x 122cm
- 100cm x 122cm
- 70cm x 100cm
- 41cm x 60cm
- 71cm x 72cm

| Product name | Size | Code | Supply chain code |
|--------------------------------------|---------------|----------------------|-------------------|
| Patient specific tubular slide sheet | 71cm x 145cm | PH420-71145---REDA06 | N/A |
| Patient specific tubular slide sheet | 71cm x 122cm | PH420-71122---REDA06 | N/A |
| Patient specific tubular slide sheet | 100cm x 122cm | PH420100122---REDA06 | N/A |
| Patient specific tubular slide sheet | 70cm x 100cm | PH420-70100---REDA06 | N/A |
| Patient specific tubular slide sheet | 41cm x 60cm | PH420-41-60---REDA06 | N/A |
| Patient specific tubular slide sheet | 71cm x 72cm | PH420-71-72---REDA06 | N/A |

ELITE PATIENT SPECIFIC TUBULAR SLIDE SHEETS



Slide sheets allow easy ultra low friction patient movement whilst reducing risk of injury to both carers and patients.

- 100cm x 200cm
- 140cm x 200cm
- 71cm x 200cm
- 90cm x 135cm
- 120cm x 150cm
- 90cm x 90cm

| Product name | Size | Code | Supply chain code |
|------------------------------------|---------------|-----------------------|-------------------|
| Elite patient specific slide sheet | 100cm x 200cm | PH020100200---REDA62 | TLC686 |
| Elite patient specific slide sheet | 140cm x 200cm | PH020140200---REDA62 | N/A |
| Elite patient specific slide sheet | 71cm x 200cm | PH020-71-200---REDA62 | N/A |
| Elite patient specific slide sheet | 90cm x 90cm | PH020-90-90---REDA62 | FES10778 |
| Elite patient specific slide sheet | 90cm x 135cm | PH020-90135---REDA62 | FES10759 |

Same day dispatch on all stocked products to UK mainland addresses. Simply buy online before 1pm*.

*Weekdays only



SLIDE SHEETS - REUSABLE

ELITE RE-USABLE FLAT SLIDE SHEETS



Durable, re-usable slide sheets allow easy ultra low friction patient movement whilst reducing injury risk to carer and patient. Launderable to thermal disinfection temperatures.

- 75cm x 200cm
- 100cm x 200cm
- 140cm x 200cm

| Product name | Size | Code | Supply chain code |
|----------------------------------|---------------|----------------------|-------------------|
| Elite re-usable flat slide sheet | 75cm x 200cm | PH007-75200---TEAA77 | N/A |
| Elite re-usable flat slide sheet | 100cm x 200cm | PH007100200---TEAA77 | FES10783 |
| Elite re-usable flat slide sheet | 140cm x 200cm | PH007140200---TEAA77 | TLC562 |

Have you seen patient transfer sheets?



Go to pg. 47

ELITE RE-USABLE TUBULAR SLIDE SHEETS



Durable, re-usable tubular slide sheets allow easy ultra low friction patient movement while reducing injury risk.

- 41cm x 60cm 71cm x 200cm
- 71cm x 72cm 75cm x 200cm
- 70cm x 100cm 100cm x 122cm
- 71cm x 122cm 100cm x 200cm
- 71cm x 145cm 90cm x 90cm
- 90cm x 135cm 140cm x 200cm

| Product name | Size | Code | Supply chain code |
|-------------------------------------|---------------|----------------------|-------------------|
| Elite re-usable tubular slide sheet | 140cm x 200cm | PH407140200---TEAA77 | TLC691 |
| Elite re-usable tubular slide sheet | 71cm x 72cm | PH407-71-72---TEAA77 | N/A |
| Elite re-usable tubular slide sheet | 71cm x 145cm | PH407-71145---TEAA77 | N/A |
| Elite re-usable tubular slide sheet | 71cm x 122cm | PH407-71122---TEA77 | N/A |
| Elite re-usable tubular slide sheet | 100cm x 122cm | PH407100122---TEA77 | N/A |
| Elite re-usable tubular slide sheet | 100cm x 200cm | PH407100200---TEA77 | TLC690 |
| Elite re-usable tubular slide sheet | 90cm x 135cm | PH407-90135---TEA77 | FES10765 |
| Elite re-usable tubular slide sheet | 90cm x 90cm | PH407-90-90---TEA77 | FES10784 |
| Elite re-usable tubular slide sheet | 75cm x 200cm | PH407-75200---TEA77 | N/A |
| Elite re-usable tubular slide sheet | 71cm x 200cm | PH407-71200---TEA77 | N/A |
| Elite re-usable tubular slide sheet | 70cm x 100cm | PH407-70100---TEA77 | N/A |
| Elite re-usable tubular slide sheet | 41cm x 60cm | PH407-41-60---TEA77 | N/A |

SLIDE SHEETS - REUSABLE

ELITE RE-USABLE FLAT SLIDE SHEETS WITH HANDLES



Durable, re-usable slide sheets with handles allow easy ultra low friction patient movement with greater control whilst reducing risk of injury to both carers and patients. Launderable to thermal disinfection temperatures.

- 72cm x 200cm
- 100cm x 200cm
- 140cm x 200cm

| Product name | Size | Code | Supply chain code |
|--|---------------|----------------------|-------------------|
| Elite re-usable slide sheet w/ handles | 72cm x 200cm | PH017-72200---TEAA77 | N/A |
| Elite re-usable slide sheet w/ handles | 100cm x 200cm | PH017100200---TEAA77 | VTS210 |
| Elite re-usable slide sheet w/ handles | 140cm x 200cm | PH017140200---TEAA77 | VTS211 |

SLIDE SHEET BAG



Red polyester bag with webbing drawstring handle is useful for storing slide sheets on the hospital ward or in care homes.

- Used to store slide sheets
- Strong webbing drawstring handle
- Available in red

| Product name | Size | Code |
|-----------------|-------------|-------|
| Slide sheet bag | 20cm x 33cm | PH810 |

Same day dispatch on all stocked products to UK mainland addresses. Simply buy online before 1pm*.

*Weekdays only



Take a look at patient handling accessories



Go to pg. 49

PATIENT TRANSFER SHEETS

TRANSFER SHEETS



Slidetex patient transfer sheet with 6 handles down each side. Used by hospital staff when moving patients. Disposable, not launderable.

- 200kg weight capacity
- Water repellent
- 6 ergonomic handles each side
- Latex free & non slippy

| Product name | Size | Code | Supply chain code |
|----------------|---------------|-------|-------------------|
| Transfer sheet | 85cm X 194cm | PH700 | VTS114 |
| Transfer sheet | 110cm x 194cm | PH700 | TLC143 |

SUPA SLIDE PATIENT SPECIFIC FLAT SLIDE SHEETS



Non-woven polypropylene disposable slide sheets are used by hospitals, clinics, nursing homes and more. Boxes of 100 slide sheets.

- 75cm x 200cm (standard size)
- 100cm x 200cm (bariatric size)

| Product name | Size | Code | Supply chain code |
|-------------------|---------|-------|-------------------|
| SUPA slide sheets | 2 sizes | PH025 | VTS200 |

IPACKS



The iPacks consist of clear plastic bag with drawstring containing two large slide sheets for patient moving and handling.

- Silicon coated polyester
- Available in red or yellow
- 100% polyester material



| Product name | Size | Code |
|--------------------|---------------|-------|
| iPack red & red | 100cm x 200cm | PH515 |
| iPack red & yellow | 100cm x 200cm | PH516 |
| iPack red & red | 140cm x 200cm | PH517 |

AIRPAL PATIENT TRANSFER SYSTEM

PATIENT SPECIFIC MATTRESS



Patient specific Airpal transfer pads are used with the Airpal patient transfer system. Wipe clean mattress pads.

- Specialized latex-free 4 way stretch layered medical fabric
- Long extension handles
- Safe working limit of 454kg (70 stones)

| Product name | Size | Code |
|----------------------------------|--------------|-------|
| Airpal patient specific mattress | 86cm x 198cm | AP020 |

RE-USABLE MATTRESS



The Airpal mattress is used by nurses and caregivers to perform a lateral transfer of a patient from one horizontal position to another. Specialized medical fabrics with cushioned platform.

- Launderable
- Compatible with X-ray and MRI
- Nickel plated brass snaps
- Safe working limit of 454kg (70 stones)

| Product name | Size | Code |
|---------------------------|--------------|-------|
| Airpal re-usable mattress | 86cm x 198cm | AP000 |

AIR SUPPLY



To be used with an Airpal patient transfer mattress to move hospital patients laterally.

The air supply powers the patient transfer with a high volume and low-pressure source of airflow.

| Product name | Size | Code |
|--------------|----------|-------|
| Air supply | One size | AP300 |

MATTRESS COVER



Mattress sani liner covers for the 86cm Airpal patient transfer mattress are available to buy online.

These launderable sani liner covers protect the Airpal re0usable mattress from spills and accidental marking.

| Product name | Size | Code |
|-----------------------|--------------|-------|
| Airpal mattress cover | 86cm x 198cm | AP100 |

PATIENT HANDLING ACCESSORIES

SLIDE SHEET EXTENSION



Extension straps are attached to slide sheets with handles to allow nurses and carers to avoid overreaching, injuries and give greater control.

- Extend reach by 90cm
- Easy loop attachment
- Handle loop for secure handling
- Launderable & reusable
- 300kg breaking strain per strap

| Product name | Size | Code |
|-----------------------|------------|-------|
| Slide sheet extension | 1.9cm long | PH800 |

SLIDETEX GLOVES



Assists nurses and carers with patient movement and comfort, removing uncomfortable creases from bedlinen and clothing by smoothing down.

- One size fits all
- 65gsm nylon with silicone coating
- 75cm x 20cm

| Product name | Size | Code | Supply chain code |
|-----------------|-------------|-------|-------------------|
| Slidetex gloves | 75cm x 20cm | PH803 | EVX503 |

STOCKING SLIDER



Putting open-toe compression stockings on patients becomes easy and quick with a stocking slider. Reduces friction. Stocking slider fabric is patient specific.

- Use with open toe compression socks
- Use with closed toe socks when inspection hole present
- Can assist with compression sleeves

| Product name | Size | Code |
|-----------------|-------------|-------|
| Stocking slider | 70cm x 22cm | PH802 |

BED LADDER STRAP



Assists patients in sitting up in bed by themselves, the bed ladder strap is made of strong fabric webbing. Easily fits to the bed.

- 100% strong polyester webbing
- 1.9 metres long
- 5 handholds and a bed attachment loop

| Product name | Size | Code |
|------------------|-----------|-------|
| Bed ladder strap | 1.9m long | PH801 |

STAFF PROTECTION (PPE)

REUSABLE FACE MASKS



Breathable high-quality mask is 3-ply, made with 2 outer layers of cotton and an inner layer of polyester mesh lining. Outer layer has Silvadur 930 Flex antibacterial treatment.

- One size fits all - elastic ear loops
- 3-ply masks
- Machine washable at 60 degrees

| Product name | Size | Code |
|----------------------------------|-------------|-------|
| Reusable face masks (individual) | 17cm x 12cm | FP100 |

KN95 FACE MASKS



Face masks can be worn to protect staff from viral and bacterial microbes. These masks have a 4-layer structure which provides a filtering effect of 95% minimum.

- Two ear loops
- Provided in packs of 10
- KN95 is the equivalent of FFP2 European regulation

| Product name | Size | Code |
|------------------------------|-----------------|-------|
| NK95 face masks (pack of 10) | 16.5cm x 10.5cm | DP300 |

DISPOSABLE 3-PLY TYPE II FACE MASKS



Blue and white 3-ply Type II disposable face masks for used as a face covering. Ideally worn when 2m distance can't be maintained.

- Provided in packs of 50
- Flexible nose bar for better protection
- Bacterial filtration efficiency (BFE) > 98%
- Complies with EN14683; 2019

| Product name | Size | Code |
|------------------------------------|----------------|-------|
| Disposable face masks (pack of 50) | 17.5cm x 9.5cm | DP310 |

DISPOSABLE 4-PLY TYPE IIR FACE MASKS



Blue and white 4-ply Type II disposable face masks for used as a face covering. Two outer layers of the 4-ply mask are made from nonwoven fabric.

- Flexible nose bar for better protection
- Bacterial filtration efficiency (BFE) > 98%
- Complies with EN14683; 2019
- Splash resistance

| Product name | Size | Code |
|--|----------------|-------|
| 4-ply type IIR face masks (pack of 50) | 17.5cm x 9.5cm | DP311 |

STAFF PROTECTION (PPE)

POLYTHENE COVERALL APRONS



Disposable polythene coverall aprons, can be worn over usual staff uniform or scrubs for protection against fluids and bacterial penetration.

- 19 Micron count
- Apron measures 77cm by 105cm
- Provided in packs of 50
- Easy rip to remove
- White aprons
- Full front and back torso coverage

| Product name | Size | Code |
|--|--------------|----------------------|
| Polythene coverall aprons (pack of 50) | 77cm x 105cm | DP200-77100---WHTV58 |

SPLASH PROOF FACE SHIELDS



Transparent medical face shield protects the entire face when worn with a face mask. Anti-fog coating prevents misting.

- One size fits all - elastic headband
- Splash proof
- Anti fog
- Wipeable & re-usable
- Protects face from coughs and sneezes

| Product name | Size | Code |
|---------------------------|---------------|---------------------|
| Face shields (individual) | 29cm x 24.5cm | FP000-29-24---CLR28 |

Same day dispatch on all stocked products to UK mainland addresses. Simply buy online before 1pm*.

*Weekdays only



SHOWER CURTAINS

WHITE SHOWER CURTAINS



Shower curtains with weighted hems and non-rusting eyelets are used extensively in hospitals and nursing homes.

To fit the shower curtains, simply hook the curtain eyelets onto the existing hooks on the shower curtain rail.

- 100% polyester material
- Machine washable
- 180cm wide x 180cm long
- 180cm wide x 200cm long

| Product name | Size | Code |
|-------------------------|---------|-------|
| Shower curtains - white | 2 sizes | SH005 |

Do you buy towels?



14 COLOURS AVAILABLE

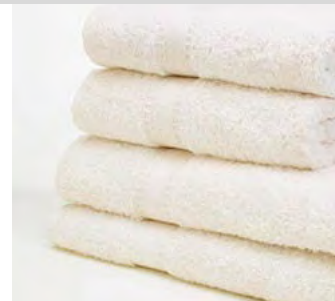

Turn to pg. 20 to see more

Same day dispatch on all stocked products to UK mainland addresses. Simply buy online before 1pm*.

*Weekdays only



LAUNDRY BAGS

POLYTHENE LAUNDRY BAGS



Polythene plastic laundry bags are used in most NHS hospitals, as well as in care homes, salons and clinics.

Whenever there is a need to transport fouled or infected linen to the laundry, these plastic bags are more hygienic and safer than using fabric equivalents.

Coloured coded for easy identification. Available in red to signify fouled, infected or biohazardous linen, also available in white and green.

- Boxes of 500 bags
- Size: 72cm x 100cm
- Red, green and white colours



| Product name | Size | Code |
|----------------------------------|--------------|-------------|
| Polythene laundry bags (50 bags) | 72cm x 100cm | LB500-72100 |

FULLY SOLUBLE POLYTHENE LAUNDRY BAGS



Designed to minimize contact with contaminated linen, these fully soluble red polythene laundry bags are ideal for simplifying the process of doing laundry.

- Dissolves in wash temperatures of approx. 60 degrees Celsius

| Product name | Size | Code |
|---|-------------|----------------------|
| Fully soluble red laundry bags (100 bags) | 77cm x 99cm | LB502-71-99---REDV59 |

LAUNDRY BAG WITH WEBBING LOOP

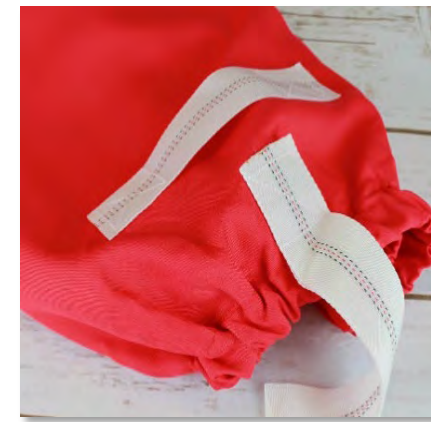

Hospital laundry bags are used in hospitals and clinics to transport soiled linen hygienically to the laundry.

- Elasticated opening at the top is designed to be wide enough to fit most laundry collection trolleys
- 100% polyester material
- Red, white, and green colours

| Product name | Size | Code |
|-------------------------------|--------------|-------------|
| Laundry bag with webbing loop | 83cm x 147cm | LB002-83147 |



interweave
healthcare

Contact details

Tel: 01422 372333

Email: sales@interweavetextiles.com

Web: www.interweavetextiles.com

Opening hours

Monday to Friday 8:30am to 5pm Closed Public Holidays

Address

Interweave House, Old Power Way, Elland, West Yorkshire, HX5 9DE, UK